



Owner's handbook

Audio system

100% Ford. 100% Entertainment.



The information contained in this publication was correct at the time of going to print. In the interest of development the right is reserved to change specifications, design or equipment at any time without notice and without incurring any obligations. This publication, or part thereof, may not be reproduced nor translated without our approval. Errors and omissions excepted.

© Ford Motor Company 2006

All rights reserved.

Order Code: 6S5J-19C104-DA (CG3508en) 01/2006 20060120121755

Table of Contents

Audio introduction.....3	Loudness control.....20
Important audio information.....3	
Radio reception.....4	
Audio unit overview.....5	
Audio system security.....7	Audio unit menus.....21
Removable front panel.....7	Automatic volume control (AVC).....21
Security code.....7	Audio distortion reduction (CLIP).....21
Lost security code.....7	Digital signal processing (DSP).....21
Entering a security code.....7	Rear seat controls (RSCP).....21
Incorrect security code.....8	Preset scan tuning.....22
Vehicle identification (VID).....8	Alternative frequencies.....22
	Music/speech.....23
	Radio data system (RDS).....23
	Enhanced other network (RDS-EON).....23
	News broadcasts.....23
	Priority programme type (PTY).....24
Audio unit clock and date displays.....10	
Setting the clock and date on the audio unit.....10	Cassette tape player.....27
	Cassette tape playback.....27
Audio unit operation...12	Fast forward.....27
On/off control.....12	Fast rewind.....27
Volume control.....12	Auto reverse.....28
Bass/treble control.....12	Ending playback.....28
Balance/fade control.....12	Cassette tape pause.....28
Phone mute control.....13	Cassette tape side selection.....29
Audio menu control.....13	Automatic music search (AMS).....29
Station preset buttons.....15	Ejecting a cassette tape.....29
Audio control.....15	
Waveband button.....16	Compact disc player.....30
Sound button.....16	Loading compact discs.....30
Autostore control.....16	Loading the compact disc changer.....31
Stereo indicator control.....17	
Traffic information (TA) control.....17	
Station tuning control.....19	

Table of Contents

Track selection.....	31
Compact disc playback.....	32
Compact disc selection.....	33
Fast forward/reverse.....	34
Shuffle/random.....	34
Compact disc track compression.....	35
Compact disc track scanning.....	35
Ejecting compact discs.....	36
Unloading the compact disc changer.....	37
MP3 file playback.....	37
MP3 display options.....	41
Repeat compact disc tracks.....	42
Ending compact disc playback.....	43
Ejecting multiple compact discs	43

Audio troubleshooting.....51

Auxiliary input (AUX IN) socket.....45

Rear passenger controls.....46

Rear seat controls.....	46
Control panel buttons.....	46
Control mode.....	47
One hour mode.....	48
Headphones.....	48
Headphone sockets.....	48
Rear passenger control display screen.....	49

Audio system care.....50

Audio unit.....	50
-----------------	----

Audio introduction

IMPORTANT AUDIO INFORMATION

WARNINGS

 Copyright laws vary from country to country; please check the laws in your country if you want to record from copyright source material.

 Due to technical incompatibility, recordable (CD-R) and rewritable (CD-RW) discs may not function correctly.

 These CD radio units will play compact discs that conform to the International Red Book standard audio specification. Copy protected CDs from some manufacturers do not conform to this standard and playback cannot be guaranteed.

 Dual format, dual sided discs (DVD Plus, CD-DVD format), now being adopted by the music industry, are thicker than normal CDs and consequently playback cannot be guaranteed in Ford and Sony CD audio units, and jamming could occur.

 Warranty claims, where this type of disc is found to be inside an audio unit returned for repair, will not be accepted.

 Apart from the 6000MP3 model, CD units are designed to play commercially pressed 12 cm audio compact discs only.

 The Sony CD unit (but not the 6CD) will play 8 cm discs with a Sony approved adaptor fitted (CSA-8).

 Irregular shaped CDs and CDs with a scratch protection film or self adhesive labels attached should not be used.

 The audio unit may be damaged if unsuitable items like credit cards or coins are pushed inside the CD aperture.

 Please contact your Dealer for further information.

Sony CD/6CD

**CLASS 1
LASER PRODUCT**

This label is located on the top of the Sony CD/6CD chassis.

**CAUTION—INVISIBLE LASER RADIATION WHEN OPEN
DO NOT STARE INTO BEAM OR
VIEW DIRECTLY WITH OPTICAL INSTRUMENTS**

This label is located on the Sony CD/6CD drive unit's internal chassis.

These units are designed to play discs that conform to the Compact Disc (CD) standard.

Recently, some record companies have marketed various music discs encoded with copyright protection.

Please be aware that among those discs, there are some that do not conform to the CD standard and may not be playable by this product.

Audio introduction

- You cannot play a CD-R/CD-RW that is not finalised. (This process is necessary for a recorded CD-R/CD-RW disc to be played on the audio CD player.)
- With the Sony CD unit, you can play MP3 files recorded on CDRoms, CD-Rs, and CDRWs.
- A CD-R/CD-RW to which a session can be added can be played.

Disc labels

Audio CD

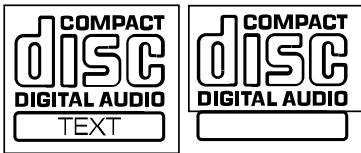

MP3



RADIO RECEPTION

Advanced digital filter adjustment (ADFA)

Sony CD/6CD

Note: Consult your dealer before switching off the filter.

Under certain **exceptional** conditions, radio reception may be adversely affected by very strong competing signals. This function allows you to switch off the digital filter to overcome this condition.

Audio unit overview

2050

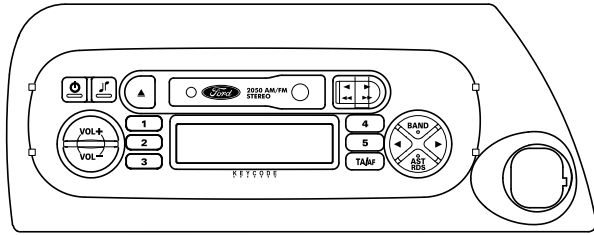

6000CD Series (with rocker volume control)

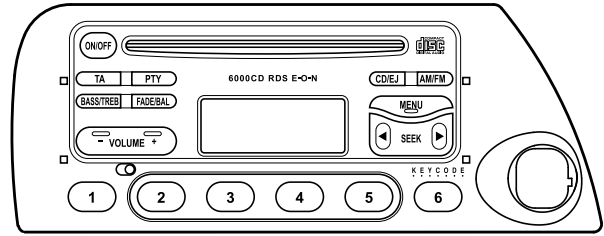

4050 and 5000

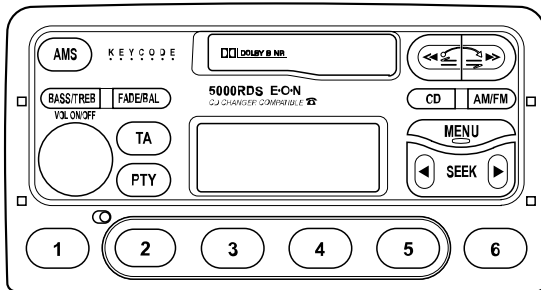

5500

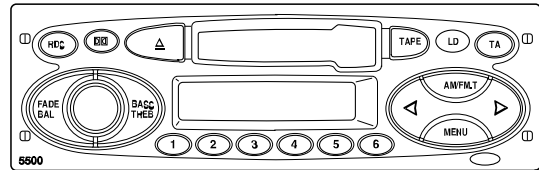

6000 CD Series

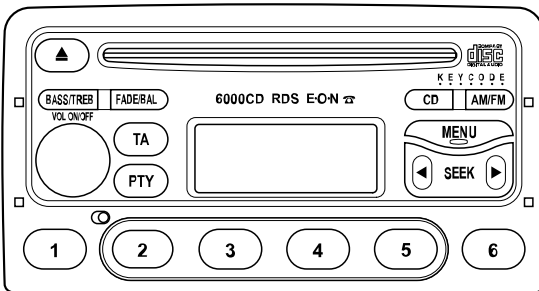

6000CD (with centrally located On/off and volume control)

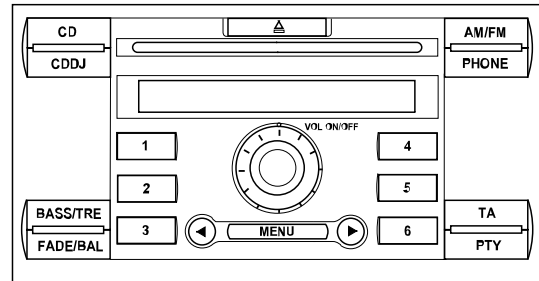

5000C

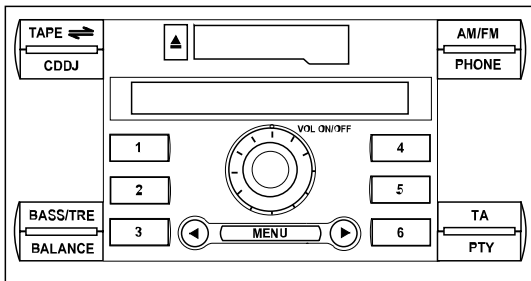

6500

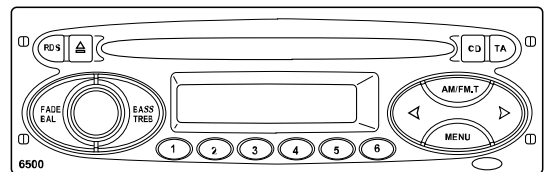

Audio unit overview

6006E

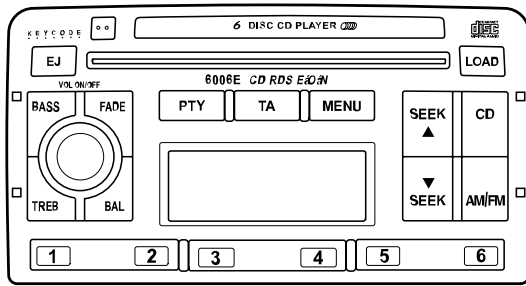

Sony CD

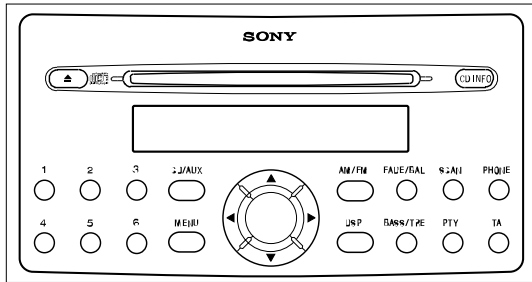

Sony 6CD

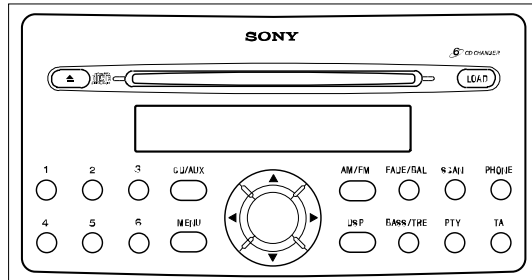

Audio system security

REMOVABLE FRONT PANEL

Note: During removal, avoid touching the contacts on the back of the panel and do not use excessive force to refit it.

- Where available slide the panel release button to the left (on 6006E units press the panel release button) and remove the panel.
- To replace the panel, insert the right-hand edge first, and then push home the left-hand side until the retaining latch is engaged.

SECURITY CODE

Most units incorporate a unique Keycode security number that must be entered before the unit will operate. Normally, the Ford Dealer does this during the predelivery inspection.

If the battery is disconnected for any reason, or the audio unit is removed from the vehicle, the Keycode must be re-entered before the unit will work again.

LOST SECURITY CODE

If you lose the Keycode, contact your dealer and supply details of your audio unit along with some proof of identity. Your Dealer will then obtain the correct code from Ford Motor Company.

ENTERING A SECURITY CODE

If 'CODE - - - -' or 'CODE 0000' appears in the display for more than 5 seconds when you switch on the audio unit, you must enter the Keycode.

On all units except 2050

1. Press button 1 repeatedly until the first digit of your Keycode is shown in the display.
2. Press preset buttons 2, 3 and 4 in the same way for remaining three digits.
3. Ensure the complete Keycode is correct before pressing preset button 5 to confirm it.

2050

1. Press button 1, use the arrow left or right arrow buttons until the first digit of your Keycode is shown in the display.
2. Repeat step 1 for the remaining 3 digits.
3. Ensure the complete Keycode is correct before pressing button 1 to confirm.

If the correct code was entered, the radio will beep and then will function normally.

Audio system security

INCORRECT SECURITY CODE

On all units except 2050

Up to TEN Keycode entry attempts are allowed with various consequences if you get it wrong.

The number of attempts is shown in the display.

- If the display reverts to 'CODE' another entry attempt may be made immediately.
- If the display shows 'WAIT 30', the unit will be locked for 30 minutes. Wait until the timer counts down to zero. When 'CODE' is displayed, enter the Keycode again.
- After ten incorrect attempts the unit will be permanently inoperative and 'LOCK 10' or 'LOCKED' will be displayed. Contact your local Ford Dealer for help.

2050

If an incorrect code was entered, the radio beeps and "WAIT" appears in the display. This indicates that a waiting period has started.

Note: Do not switch off the radio when the display shows "WAIT". Turning off the radio will cause the waiting period to start all over again.

- You must wait until the display changes to "CODE" this indicates that the waiting period has finished and the correct code can be entered.
- The waiting period doubles each time an incorrect code is entered. (1 minute, 2 minutes, 4 minutes, etc)

VEHICLE IDENTIFICATION (VID)

Note: For the location of the vehicle identification number on your vehicle, please refer to your Owner's handbook.

On all units except 2050

1. Press and hold the MENU button, then press it repeatedly to select a VID display. On Sony units, press and hold the MENU button.
2. The current vehicle identification number will be displayed or, if a number has yet to be entered, 'NO VID', 'VID 00000' or 'CODE ----' appears.
3. Enter your Keycode.
4. The audio unit will mute and the display will show either a previously entered vehicle identification number or a flashing cursor or a display of zeros.

Audio system security

5. Use the left/right arrow buttons to move across the display, and use the volume control or the up/down arrow buttons on Sony CD/6CD, to select or change the individual characters. A total of 15 or 16 characters can be stored.
6. When all the characters have been selected, press MENU to store the number. The unit then returns to normal operation.

On some units, the number appears in the display whenever power is restored. To check the vehicle identification number, repeat steps 1 and 2 then press the MENU button.

Audio unit clock and date displays

SETTING THE CLOCK AND DATE ON THE AUDIO UNIT

All units, except the 2050, the 5000C, the 6000CD with centrally located on/off and volume control, and Sony CD/6CD, have a built in facility that will receive RDS data for a current time and date display. When first switched on, a series of bars may be displayed until the signal is received.

In all cases, the time derived from the signal is exact and in most units it cannot be altered. Some units, however, do allow you to set the time manually.

On certain models, where possible, adjustments are made as follows:

- Press and hold the MENU button for approximately two seconds until the display changes.
- Press the MENU button repeatedly until a 'CLK-MAN' or 'RDS TIME OFF' display appears.
- Use the SEEK buttons to select 'CLK-AUTO' or 'RDS TIME ON'.

Note: With 'CLK-AUTO' or 'RDS TIME ON' selected, the time will be set automatically via the RDS function if an RDS signal is available. In this case you will not find a time display to set the time manually.

If you observe after setting 'RDS TIME' to 'ON', that the clock is not set properly, then the radio station selected does not support RDS clock setting.

In this case, either select another radio station which transmits a time signal or set the clock manually.

Note: If any of these features are not available in your unit, the relevant menu options will not be displayed.

2050

The clock is located on the instrument panel please refer to your Owner's handbook for instructions.

5000C and 6000CD with centrally located on/off and volume control

Changing the date and time

- Press the CLOCK button to display the date and time.

Note: If you do not press another button within 30 seconds of pressing the CLOCK button, the display will return to its previous setting.

- Use the SEEK buttons to select the date or time value that you wish to change. The selected value will flash in the display.
- Turn the volume control to change the selected date or time value.
- Use the SEEK buttons to select additional date or time values that you wish to change.
- Turn the volume control to change the selected date or time value.
- Press the CLOCK button to exit and save the new date and time.

Audio unit clock and date displays

Note: If you do not press the CLOCK button within 30 seconds of changing a date or time value, the display will exit and save the new values automatically.

Tip: Press and hold the CLOCK button for more than two seconds to automatically select the hour value for winter or summer time adjustment.

12/24 hour format

- Press the MENU button repeatedly until a 12/24 hour clock display appears.
- Use the SEEK button to select the setting required.
- Press the MENU button again to confirm the selection.

Sony CD/6CD

Changing the date

- Press the MENU button and use the up/down arrow buttons until a date setting display appears.
- Use the left/right arrow buttons to select days which flash in the display.
- Use the up/down arrow buttons to make an adjustment, then press the left/right arrow buttons to select months/years and adjust accordingly.
- Press the MENU button to confirm the date.

Changing the time

- Press the MENU button and use the up/down arrow buttons until a clock display appears.
- Use the left/right arrow buttons to select hours which will flash in the display.
- Use the up/down arrows to make an adjustment, then press the left/right arrow buttons to select minutes and adjust accordingly.
- Press the MENU button to confirm the time.

12/24 hour format

- Press the MENU button and use the up/down arrow buttons until a 12/24 hour clock display appears.
- Use the left/right arrow buttons to select the setting required.
- Press the MENU button to confirm your selection.

Audio unit operation

ON/OFF CONTROL

- Press the on/off control to turn your unit on or off. This will also operate the unit for up to one hour with the ignition turned off. The radio will switch off automatically after one hour.

2050

Note: CODE will briefly flash in the display when the unit is turned on. This is a normal system function the security code is not required to be entered.

VOLUME CONTROL

Use this control to raise or lower the volume of the current audio source at any time. When you make an adjustment, the display indicates the selected volume level.

On some audio units, the volume control is also used in conjunction with certain menu functions to make other adjustments.

BASS/TREBLE CONTROL

All units, except the 2050, to adjust the amount of bass or treble response from any audio source. On 2050 See Sound button (page 16).

- Where the adjustment is featured on a single button, press the button once for bass or twice for treble.
- Where there are separate buttons, press the required button once.
- Use the volume control or, on Sony CD/6CD, the up/down arrow buttons to make the necessary adjustment.

The display indicates the level selected.

Default audio settings

On 5500/6500 units, press and hold BASS/TREB until the default audio display appears. With the function switched on, all the audio setting return to the manufacturer's original preset levels.

BALANCE/FADE CONTROL

All units, except the 2050, the BALANCE control is used to adjust the sound coming from the left and right speakers. On 2050 See Sound button (page 16).

All units, except the 2050, the FADE control is used to adjust the sound distribution from front to rear in vehicles equipped with rear speakers. When 6006E is fitted in vehicles without rear speakers, 'No Rear' is displayed if the FADE button is pressed.

Audio unit operation

- Where the adjustment is featured on a single button, press the button once for fade or twice for balance.
- Where there are separate buttons, press the required button once.
- Use the volume control to make the necessary adjustment.
- Or, on Sony CD/6CD, use the up/down arrow buttons for fade adjustment, and left/right arrow for balance adjustment.

The display indicates the level selected.

PHONE MUTE CONTROL

- Where available, press the PHONE button to mute your audio unit.
- Press PHONE again to unmute.

AUDIO MENU CONTROL

Where available use the MENU button to access features that cannot be selected directly via one of the button controls. Press the MENU button for 'first level' features, or press and hold the MENU button for different 'second level' functions.

Features that are not available do not appear in the display.

Audio unit operation

Sony CD/6CD

Menu features - First level features				Second level functions
During radio reception	During tape playback	During CD playback	During CD changer playback	During all functions
RSE*		RSE*	RSE*	VID
Clock		Clock	Clock	CLIP ON/OFF
Date		Date	Date	Aux ON/OFF
12/24 hour		12/24 hour	12/24 hour	News ON/OFF
AVC		Scroll	AVC	Bluetooth enable/disable
Traffic local or distant		AVC	Repeat	ADFA ON/OFF
AF		Repeat	Comp	
		Comp	Shuffle	
		Shuffle		

Note: The sequence in which features appear may vary for different audio units and vehicles.

* Only when fitted.

Audio unit operation

5000C/6000CD

Menu features - First level features				Second level functions
During radio reception	During tape playback	During CD playback	During CD changer playback	During all functions
Manual tuning	Track number	Scan	Scan	Traffic local or distant
Scan tuning	Clock	Shuffle	Shuffle	AF
Clock	Date	Repeat	Repeat	VID
Date	12/24 hour	Comp	Comp	CLIP
12/24 hour	AVC	Clock	Clock	News
AVC		Date	Date	Bluetooth enable/disable
		12/24 hour	12/24 hour	
		AVC	AVC	

Note: The sequence in which features appear may vary for different audio units and vehicles.

* Only when fitted.

STATION PRESET BUTTONS

This feature allows you to store your favourite stations so that they can be recalled by selecting the appropriate waveband and pressing one of the preset buttons.

- Select a waveband.
- Tune to the station required.
- Press and hold one of the preset buttons. The audio unit will mute. When sound returns or, on certain units, a bleep sounds, the station has been stored.

This can be repeated on each waveband and for each preset button.

Note: When you drive to another part of the country, FM stations that broadcast on alternate frequencies, and are stored on preset buttons, may be updated with the correct frequency for that area.

AUDIO CONTROL

Where available, this control combines all the sound adjustment features – bass, treble, balance and fade – in one button.

Audio unit operation

- Press AUDIO repeatedly to select the required item.
- Use the volume control to make the necessary adjustment. The display indicates the level selected.

WAVEBAND BUTTON

This control allows you to switch between the LW, MW and AM waveband, where available and the FM waveband.

If you press the button repeatedly during radio reception, you can select from the wavebands available. The display indicates the selection made.

On some units the selector can also be used to return to radio reception when you have been listening to a tape cassette or CD.

SOUND BUTTON

2050 only

Note: The sound button can be identified by the two music note symbols.

Sound style

- Press sound once to reach music settings, to scroll through the settings use the volume up/down buttons.

Setting	Sound style
FLAT	Original.
JAZZ	Jazz music.
VOCAL	Speech.
POP	Pop music.
CLASSIC	Classical music.
ROCK	Rock music.

Bass/treble/balance and loudness

- Press SOUND twice to select bass adjust the settings with the volume up/down buttons.
- Press SOUND three times to select treble adjust the settings with the volume up/down buttons.
- Press SOUND four times to select balance adjust the settings with the volume up/down buttons.
- Press SOUND five times to select loudness adjust the settings with the volume up/down buttons.

After 5 seconds the display goes back to the last mode of operation.

AUTOSTORE CONTROL

Where available, AutoStore can be used to store the up to six stations on some units, with the strongest signals receivable, either from the FM waveband or from LW, MW, AM and FM (where available).

Audio unit operation

- Press and hold the waveband button. On 2050 short press the AST button.
- The sound mutes and on some units a beep is heard and an 'AST' or 'AUTOSTORE' display appears while the unit searches through the frequencies.
- When the search is complete, sound is restored and the strongest signals are stored on the AutoStore presets.

Each time AutoStore is activated, the unit will store station frequencies from the waveband last selected and replace stations previously stored.

Note: The AutoStore feature can also be used to store stations manually in the same way as other wavebands.

STEREO INDICATOR CONTROL

On all units except 2050

Where available this shows whenever a stereo signal is being received on the FM waveband. On some units it may be displayed as 'ST'; on others it will be the accredited stereo symbol.

In poor signal conditions, the indicator may flicker, or it may disappear completely if the stereo signal is lost altogether.

2050

The 2050 unit selects stereo or mono mode automatically according to signal strength.

TRAFFIC INFORMATION (TA) CONTROL

Many stations broadcast on the FM waveband have a TP code to signify that they carry traffic programme information this may appear in your radio display.

Activating traffic announcements

Before you can receive traffic announcements, you must press the TA button. A 'TA' display will appear to show the feature is switched on.

Note: On 2050 units a short press to reach the TA feature.

If you are already tuned to a station that broadcasts traffic information, 'TA' or 'TP' will also be displayed. Otherwise the unit will search for a traffic programme and display 'TA SRCH' or 'TP SEEK' while doing so. If it cannot locate such a station, 'Not Found' or 'NO TA' will be displayed.

On some units 'TP' appears within a box when you are tuned to a station providing traffic from a linked RDS-EON station.

When traffic information is broadcast, it will automatically interrupt normal radio, tape or CD playback and 'TRAFFIC' will appear in the display.

Audio unit operation

If the traffic signal weakens, 'TP' or 'TP LOST' will flash in the display and on some units a beep will be heard. Press the SEEK button or, the left/right arrow buttons to find another station. Some units will automatically retune to another traffic station.

If a non-traffic station is selected or recalled using a preset button, the audio unit will remain on that station unless:

- TA is turned off, then on again.
- On certain models, the volume control is set to zero for four minutes after which the audio unit will retune to another traffic station.

Local or distant traffic

The number of RDS (EON-) traffic announcements may become excessive in some areas so there is an option on some units to select between local traffic information and all available information.

Sony CD/6CD

- Press the MENU button and use the up/down arrow buttons to select a TA display.
- Use the left/right arrow buttons to select the setting required.
- Press the MENU button to confirm your selection.

All other units except Sony CD/6CD and 2050

- Press and hold the MENU button until the display changes.
- Press the MENU button repeatedly until a TA display appears.
- Use the SEEK or left/right arrow buttons to select either local ('TA-LOCAL') or distant ('TADIST') traffic announcements.
- 'TA-L or 'TA-D' appear in the display to show which has been selected.

2050

On 2050 units the radio is permanently set on distant traffic announcements.

Traffic announcement volume

Traffic announcements interrupt normal broadcasts at a preset minimum level that is usually louder than normal listening volumes.

To adjust the preset volume on all units except 2050:

- Press and hold the TA button.
- Use the volume control or, on Sony units, the up/down arrow buttons to make the necessary adjustment. The display will show the level selected.

To adjust the volume on 2050:

- When the traffic announcement is broadcasting adjust the volume using the volume up/down buttons.

Audio unit operation

Ending traffic announcements

The audio unit will return to normal operation at the end of each traffic announcement. To end the announcement prematurely, press TA during the announcement.

Note: If you press TA at any other time it will switch all announcements off.

STATION TUNING CONTROL

Seek tuning

Select a waveband and briefly press one of the SEEK or arrow buttons. The unit will stop at the first station it finds in the direction you have chosen.

Manual tuning

Sony CD/6CD

- Press the up/down arrow buttons. The display shows the frequency selected.

All units except 2050

- Press the MENU button repeatedly until a MAN display appears.
- Then press one of the SEEK arrows to tune down or up the waveband in small increments, until you find a station you want to listen to.

2050

- Long press one of the left or right arrow buttons for more than 2 seconds to reach manual tuning.
- Press one of the left or right arrow buttons to tune down or up the waveband in small increments, until you find a station you want to listen to.
- Press and hold to tune up or down quickly.

Note: When the keys are released, a time-out will start to count. After 5 seconds a time-out, display 'Auto' will appear and a beep beep will be heard and then returns to automatic search.

Scan tuning

Note: This feature is not available on certain units and may not appear as a menu option.

Sony CD/6CD

- Press the SCAN button. 'SCAN' flashes in the display and each station is played for a few seconds.
- Press SCAN again to continue listening to a station.

Audio unit operation

All units except 2050

- Press the MENU button repeatedly until a SCAN display appears.
- Use the SEEK button to scan up or down the selected waveband. 'Scn' or 'SCAN' flash in the display and each station is played for a few seconds.
- Depending on the audio unit, press SEEK or MENU again to continue listening to a station.

LOUDNESS CONTROL

6500

- Press the MENU button repeatedly until a loudness display appears.
- Then use the left/right arrow buttons to switch this function on or off.
- With this function activated, the unit automatically detects low volume audio output and raises the level of bass frequencies.

Audio unit menus

AUTOMATIC VOLUME CONTROL (AVC)

AVC automatically adjusts the volume level to compensate for engine noise and road speed noise. When available:

- Press the MENU button repeatedly until an AVC display appears.
- Use the SEEK button, or the left/right arrow buttons, to adjust the AVC setting.
- Or, on Sony CD/6CD, press the MENU button briefly and use the up/down arrow buttons to select an AVC display.
- Press the MENU button to confirm your selection.

AUDIO DISTORTION REDUCTION (CLIP)

CLIP automatically detects sound distortion and reduces the unit's volume level until the distortion has been eliminated. This means that whilst the display might change numerically when you raise the volume manually with the control, there may be no actual increase in sound. When available:

- Press and hold the MENU button until the display changes. Then press MENU repeatedly until a CLIP display appears.
- Use the SEEK button, or the left/right arrow buttons, to turn the function on or off.

- Or, on Sony CD/6CD, press and hold the MENU button until the display changes, and use the up/down arrow buttons to select a CLIP display.
- Press the MENU button to confirm your selection.

DIGITAL SIGNAL PROCESSING (DSP)

Where available, DSP provides a choice of preset acoustic environments, which may include settings like 'JAZZ', 'CONCERT', 'CHURCH', 'STADIUM', 'POP', 'CLASSICAL' or 'ROCK'.

- Press the DSP button repeatedly until a DSP display appears.
- Use the volume control or, on Sony units, the up/down arrow buttons, to select the setting required and the display confirms your selection.

Where available, these settings may be further customised to suit the current occupants of the vehicle.

For example, 'OPTIMISED ALL' gives a conventional stereo environment, 'OPTIMISED RIGHT' and 'OPTIMISED LEFT' alter the left/right sound balance and 'REAR' gives rear seat passengers a reduced level of bass response for improved comfort.

REAR SEAT CONTROLS (RICP)

Where this feature is available:

Audio unit menus

- Press and hold the MENU button until the display changes.
- Press the MENU button repeatedly until an RICP display appears.
- Use the SEEK button to select either 'RICP ON' or 'RICP-OFF'.

PRESET SCAN TUNING

- Where available, press the MENU button repeatedly until a 'P-SCAN' display appears.
- Use the SEEK button to scan up or down the frequencies stored on the presets. 'Scn' flashes in the display and each station is played for a few seconds.
- Press any preset or MENU again to continue listening to a station.

ALTERNATIVE FREQUENCIES

Many programmes broadcast on the FM waveband have a programme identification (PI) code, which can be recognised by audio units.

If your radio has AF tuning switched on and you move from one transmission area to another, this facility will search for and switch to a stronger station signal, if one can be found.

Under certain conditions, however, alternative frequency tuning may temporarily disrupt normal reception.

With 'AF-ON' or 'AF-AUTO' selected, the unit continually evaluates signal strength and, if a better signal becomes available, the unit will switch to that alternative. It mutes while it checks a list of alternative frequencies and, if necessary, it will search once across the selected waveband for a genuine alternative frequency.

It will restore radio reception when it finds one or, if one is not found, the unit will return to the original stored frequency. On certain units, 'Not Found' will be displayed.

On some units with 'AF-MAN' selected, the unit operates in a similar way to 'AFAUTO' or 'AF-ON', but only searches for an alternative frequency when prompted by pressing a preset button.

With 'AF-OFF' selected, the original stored frequency remains selected. In this mode, 'AF-OFF' will be displayed every time the unit is turned on.

Sony CD/6CD

- Press the MENU button and use the up/down arrow buttons to select an 'AF' display.
- Use the left/right arrow buttons to select the setting required.
- Press the MENU button to confirm your selection.

Audio unit menus

All other units except 2050

- Press and hold the MENU button until the display changes.
- Press the MENU button repeatedly until an 'AF' display appears.
- Use the SEEK or left/right arrow buttons to select the setting required.

2050

- Short press the AF button to turn AF-ON.
- Repeat the step above to turn AF-OFF.

MUSIC/SPEECH

5500/6500

- Press and hold the MENU button until the display changes.
- Press the MENU button repeatedly until a music/speech display appears.
- Then use the left/right arrow buttons to make a selection.

RADIO DATA SYSTEM (RDS)

Most radio stations on the FM waveband transmit additional code in their broadcast signal that allows receivers equipped with the necessary decoder to present more information to the listener. This is known as the Radio Data System (RDS).

When this information is available, the additional features may include the station name, the station's programme identification number, alternative broadcasting frequencies and traffic information.

ENHANCED OTHER NETWORK (RDS-EON)

There is also a feature-enhanced version known as Radio Data System – Enhanced Other Networks (RDS-EON) that provides even more information such as radio text and programme type coding.

Note: Certain features may not be available from all radio stations.

NEWS BROADCASTS

Where available apart from selecting NEWS as a PTY selection, some audio units interrupt normal reception to broadcast news bulletins from stations on the FM waveband or RDS-EON linked stations, in the same way as traffic information is provided.

Audio unit menus

During news broadcasts, the display alternates between the station name and 'NEWS'. News interrupts are broadcast at the same preset volume level as traffic announcements.

Sony CD/6CD

- Press and hold the MENU button until the display changes.
- Use the up/down arrow buttons to select a 'NEWS' display.
- Use the left/right arrow buttons to select the setting required.

All other units except Sony CD/6CD and 2050

- Press the MENU button repeatedly or, where available, press and hold the PTY button, until a 'NEWS' display appears.
- Use the SEEK button to turn the function on or off.

PRIORITY PROGRAMME TYPE (PTY)

Many programmes in the FM waveband are categorised by the type of material they broadcast. This classification takes the form of an identification number coded into the broadcast signal.

On designated units, searches can be based on one of these classifications so that you can choose to listen to a particular type of programme.

Audio unit menus

Classification	Description
AFFAIRS	Current affairs
ALARM	See note below
CHILDREN	Children's programmes
CLASSICS	Classical music
COUNTRY	Country music
CULTURE	
DOCUMENT	Documentary content
DRAMA	
EASY	Easy listening music
EDUCATE	Educational content
FINANCE	
FOLK M	Folk music
INFO	Information
JAZZ	
LEISURE	
LIGHT M	Light music
M.O.R.M	Middle of the road music
NATION M	National music
NEWS	
NONE	Not categorised
OLDIES	Old time music
OTHER M	Music not covered elsewhere
PHONE IN	
POP M	Pop music
RELIGION	
ROCK M	Rock music
SCIENCE	Scientific content
SOCIAL	
SPORT	
TRAVEL	
VARIED	Mixed programme content
WEATHER	

Audio unit menus

Note: Some radio stations can also transmit emergency information under the undocumented category of ALARM but this programme type cannot be selected manually.

Selecting PTY

- Press the PTY button or the MENU button repeatedly until a PTY display appears.

Selecting stations with the same programme type

Activate PTY and while PTY is displayed:

- Use the SEEK button or the left/right arrow buttons to locate other stations broadcasting programmes of the type selected.

Selecting stations with different programme types

Activate PTY and while PTY is displayed:

- Use the volume control or, on Sony units, the up/down arrow buttons to select another programme type.
- Then use SEEK or the left/right arrow buttons to locate a station broadcasting the selected programme type.

Using PTY

While the audio unit is searching for another PTY station, a PTY search display appears. When a programme is found, the new station name flashes in the display and radio reception is restored from the station selected.

If the new station is not required, while its name is still flashing, press SEEK again or the left/right arrow buttons to find another station broadcasting the same programme type.

Note: If a station transmitting the same type of programme cannot be found, 'Not Found' is displayed and the radio returns to the original station.

PTY selection during tape or CD playback

- Select PTY and use the controls as described above. CD playback continues, but radio reception is restored when the search is completed.
- If a station is not found, press the PTY or MENU buttons or the waveband selector, depending on the audio unit, to cancel the search.

Cassette tape player

CASSETTE TAPE PLAYBACK

Note: Always remove cassettes from the unit when your not using them.

All units automatically switch to tape operation as soon as a cassette is inserted. On some units during radio reception when a tape is already inserted, press the TAPE control buttons to start tape playback. On 2050 units the tape must be ejected to return to radio reception.

On 2050 the direction of playback is shown by a left or right arrow in the display.

FAST FORWARD

Radio reception is automatically restored when you fast forward while the tape is playing. Press the left/right arrow buttons or, on certain models, press the TAPE button to revert to tape playback.

5500

- Press the right arrow button twice.
- Press the left arrow button to end fast forward and restart the tape.

All other units except 2050

- Press the right arrow button fully in.
- Press and release the left arrow button to end fast forward and restart the tape.

2050

The direction of fast winding depends on the direction of play indicated by the left or right arrow in the display.

- If the play display shows a right arrow, press the double right arrow button to fast forward.
- If the play display shows a left arrow, press the double left arrow button to fast forward.

If you continue fast winding until the end of the tape, playback restarts automatically.

To stop fast winding before the end of the tape press the key which is not pressed the left double arrows or the rights double arrows. Playback is then resumed.

FAST REWIND

Radio reception is automatically restored when you fast rewind while the tape is playing. Press the left/right arrow buttons or, on certain models, press the TAPE button to revert to tape playback.

When the beginning of the tape is reached, press the left/right arrow buttons part way in to restart playback. If rewind is engaged while you are listening to the radio, tape playback will restart automatically when the beginning or, on certain models, the end of the tape is reached.

Cassette tape player

5500

- Press the left arrow button twice.
- Press the right arrow button to end fast rewind and restart the tape.

All other units except 2050

- Press the left arrow button fully in.
- Press and release the right arrow button to end rewind and restart the tape.

2050

The direction of fast rewinding depends on the direction of play indicated by the left or right arrow in the display.

- If the play display shows a right arrow, press the double left arrow button to fast rewind.
- If the play display shows a left arrow, press the double right arrow button to fast rewind.

If you continue to fast winding until the end of the tape, playback restarts automatically.

To stop fast winding before the end of the tape press the key which is not pressed the left double arrows or the rights double arrows. Playback is then resumed.

AUTO REVERSE

On certain units, when the end of the tape is reached, the tape auto reverses and playback resumes at the beginning of the other side.

On other units you may have to eject the cassette and turn it over.

ENDING PLAYBACK

On all units except 2050

- Press AM/FM to restore radio reception, or the CD button to restore CD playback when a changer is fitted.

2050

To restore radio reception or end tape playback the tape must be ejected.

CASSETTE TAPE PAUSE

2050

- Using the volume control adjust the volume to 0 the tape playback will then pause.
- Using the volume control adjust the volume up to resume tape playback.

4000

- Press the left/right arrow buttons partially in. This will restore radio reception.

Cassette tape player

4050, 5000 and 5000C

- Press AM/FM to restore radio reception, or the CD button to restore CD playback when a changer is fitted.
- Press the left/right arrow buttons partially in to restart tape playback.

CASSETTE TAPE SIDE SELECTION

The 2050, 4050, 5000 and 5500 units are able to play both sides of the tape without removing the cassette from the unit.

During tape playback, you can make the unit play the other side of the tape by pressing the TAPE button or press both the left and right arrow buttons partially in.

AUTOMATIC MUSIC SEARCH (AMS)

This feature allows you to move directly to the next or previous track by using the direction buttons.

4050/5000 with a rotary volume control

- Press the AMS button to turn the feature on or off.

5000 with a rocker volume control

- Press the MENU button repeatedly until an 'AMS' display appears.
- Use the SEEK button to turn this function on or off.

When this feature is on:

- Press the left/right arrow buttons to select the start of the previous or next track.

5500

- Press the left/right arrow buttons to select the start of the previous or the next track.
- Press the opposite direction button to end the search.

EJECTING A CASSETTE TAPE

This will eject the tape and restore radio reception.

2050, 5000C and 5500

- Press the eject button.

All other units except 5000C and 5500

- Press both the left/right arrow buttons fully in.

Compact disc player

LOADING COMPACT DISCS

6500 and 6000CD

Insert a CD in the slot.

6006

To load a single CD:

- Press and release the LOAD button. 'WAIT' will appear in the display.
- When the message changes to 'INSERT', and lights flash in the CD entry slot, insert a CD into the audio unit.

To load more than one CD:

- Press and hold the LOAD button until 'WAIT' appears in the display.
- When this message changes to 'INSERT', and lights flash in the CD entry slot, insert a single CD, label side up, into the audio unit.
- One of the disc icons will flash in the display and the word 'LOAD' will appear. When the disc is loaded, a number in one of the disc icons will indicate its location.
- The display will change to 'WAIT' and then the word 'INSERT' will appear again. At this point, you can load another CD.
- Repeat the last step to load more CDs.

Note: You can only load six CDs. If LOAD is pressed again, the display will show 'FULL'.

Do not try to insert a CD into the unit when 'WAIT' is displayed. Do not insert two CDs in a figure of eight fashion with edges overlapping.

WARNING



If the power to 6006 units has been disconnected, then reconnected, the unit will automatically check for the presence of discs in the magazine. This will take approximately 45 seconds. During this time all functions except Keycode entry will be locked out.

Sony CD

- Insert a CD, label side up, into the slot.
- 'LOADING', 'READING CD' and 'AUDIO CD' or 'MP3 CD' appears in the display and playback starts automatically.

Sony 6CD

To load a single CD:

- Press and release the LOAD button. 'PLEASE WAIT' appears in the display.
- When this changes to 'PLEASE LOAD', insert a CD, label side up, into the audio unit.
- A numbered disc icon flashes in the display and 'LOADING' and 'READING CD' will appear as the disc is loaded into the first available space.
- The disc icon revolves to confirm the disc is loaded, and playback starts automatically.

Compact disc player

To load more than one CD:

- Press and hold the LOAD button. 'INSERT ALL' and then 'PLEASE WAIT' appear in the display.
- When this changes to 'PLEASE LOAD', insert a CD, label side up, into the audio unit.
- 'LOADING' appears with a disc location icon, followed by 'PLEASE LOAD' again, and this repeats until a maximum of six discs have been loaded.
- Playback starts from the last disc inserted.
- If the LOAD button is pressed after six discs have already been loaded, 'ALL CDs FULL' will appear in the display.

- Remove the magazine.
- Insert one disc into each slot with the label facing upwards. There will be a click when the disc is in the correct position.
- Reinsert the magazine in the direction indicated by the arrow on the magazine. The magazine will click into position ready for use.
- Close the changer door.

Do not insert more than one disc into a single slot and always keep the disc changer door closed while the magazine is inserted.

Note: For the location of the CD changer, please refer to your Owner's Handbook.

LOADING THE COMPACT DISC CHANGER

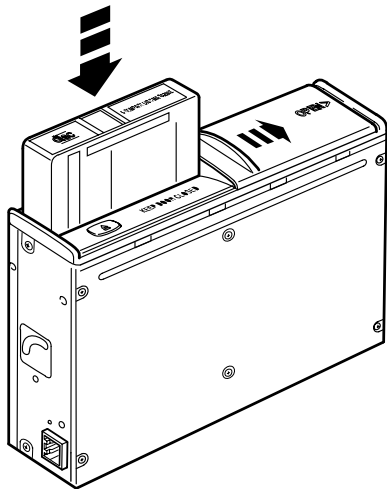

- Slide open the door on the CD changer unit.
- Press the eject button.

TRACK SELECTION

Sony CD/6CD

The left/right arrow buttons are used to navigate from track to track on the current disc.

- Press the right arrow button to move to the next track.
- Press the right arrow button repeatedly to access later tracks.
- Press the left arrow button to replay the current track. If pressed within a few seconds of the start of a track, the previous track will be selected.
- Press the left arrow button repeatedly to select previous tracks.

Compact disc player

Except Sony CD/6CD

- Press the right or up arrow buttons once to move to the next track or press it repeatedly to access later tracks.
- Press the left or down arrow buttons once to replay the current track. If pressed within three seconds of the start of a track, the previous track will be selected.
- Press the left or down arrow buttons repeatedly to select previous tracks.

COMPACT DISC PLAYBACK

Sony CD/6CD

During radio reception, press the CD/AUX button once to start CD playback.

Radio reception is automatically cut off when you play a CD, but CD playback may be interrupted from time to time, if the traffic announcement or news broadcast features are switched on.

In these audio units, when one conventional CD has been loaded, playback will start immediately the disc is loaded.

Except Sony CD/6CD

- Press the CD or CD/EJ button once to start CD playback.

Radio reception is automatically cut off when you play a CD but, on certain models, CD playback may be interrupted from time to time if the traffic announcement or news broadcast features are switched on.

In single or multiple disc players where only one conventional CD has been loaded, playback will start immediately the disc is loaded.

In multiple disc players, if two or more CDs are loaded one after the other, playback will start with the last CD loaded.

CD changer playback

On a cassette tape unit attached to a CD changer, or on the 6000CD unit when there is no CD in the internal player:

- Press the CD, CDDJ or CD/EJ button once to operate the CD changer.

On 6000CD audio units with an AUX button:

- Press the CD button twice for CD changer playback.

If there is already a disc in the internal player of the 6000CD unit, but you want to play a disc in the CD changer:

- Press the CD or CD/EJ button twice, if the unit has a rotary volume control.
- Press the CD button three times, if it has a rocker volume control.
- Press the CDDJ button.

Compact disc player

Note: On the 6000MP3 unit, you should press the CD button three times to activate the CD changer.

If the CD button is pressed when no discs are loaded, the display will show 'NO DISCS'.

Note: During playback, the display indicates the time that has elapsed since the start of the track.

On certain models, the display continues up to 99:99 before resetting to zero. On other models, if the display exceeds the maximum allowed, the first digit will flash and the displays resets to zero.

COMPACT DISC SELECTION

Sony 6CD

On Sony 6CD audio units, when the CD button is pressed, playback will recommence from wherever it was last stopped.

If that disc is no longer available, playback will start from the next disc and then continue in ascending order, i.e. disc three follows disc two. When the disc in the highest loading position has been played, playback will continue with the disc in the lowest loading position and go through the same cycle.

You can, however, switch to a disc of your choice by pressing the preset button, which has the number corresponding to the disc you want to play. 'CHANGING CD' is displayed and an icon shows the disc selected.

You can also press the up/down arrow selection buttons to select the previous disc or the next disc available. 'CHANGING CD' appears in the display and playback restarts automatically.

The audio unit remembers which discs are available so it will not select a disc that it knows to be missing. If you select a missing disc using the preset buttons, 'NO CD' will be displayed and playback will continue from the current disc.

6006CDC

On multiple CD units, including CD changers, discs are normally played sequentially in ascending order.

You can, however, switch to a disc of your choice by pressing the radio preset button with the number that corresponds to the disc you want to play. The display will show which disc is selected.

The audio unit remembers which discs are available so it will not select a disc that it knows to be missing. If you select a missing disc, the display will show 'NO CD' and playback will continue from the current disc.

Compact disc player

If a selected disc is damaged or upside down, the warning 'CD ERROR' flashes and the disc number is displayed. The unit then selects the next available disc.

If a changer is fitted, but the magazine is missing or incorrectly inserted, 'NO MAGAZINE' will appear in the display when the changer is selected and radio reception will be resumed.

FAST FORWARD/REVERSE

- Press and hold the left/right arrow buttons to search backwards or forwards within the tracks on the disc.

SHUFFLE/RANDOM

Random track playback, also known as shuffle, plays all tracks on the CD in random order.

Sony CD

- Press the MENU button and use the up/down arrow buttons to select a 'SHUFFLE' display.
- Use the left/right arrow buttons to select 'SHUFFLE CD' or 'SHUFFLE OFF'.
- When an MP3 CD is playing, options include 'SHUFFLE CD', 'SHUFF FOLDER' to play all the tracks in a folder in random order, and 'SHUFFLE OFF'.

Sony 6CD

- Press the MENU button and use the up/down arrow buttons to select a 'SHUFFLE' display.
- Use the left/right arrow buttons to select 'SHUFFLE CD', 'SHUFFLE ALL' to play all the tracks on all the loaded discs in random order, or 'SHUFFLE OFF'.

Except Sony CD/6CD

- Press the MENU button repeatedly until a 'SHUF' display appears.
- Use the SEEK button to turn the function on or off.

With the function on, 'SHUF' or 'SHUFFLE' appears in the display as each new track is selected and the elapsed time indicator is replaced by 'SHUF' as each new track is selected.

If an optional CD changer is fitted, the audio unit plays all the tracks on the current disc then moves onto the next disc in the CD magazine and plays the tracks on that in random sequence.

On certain models, where available, use the MENU and SEEK buttons for shuffle playback across all the discs in a CD changer.

When an MP3 CD is playing, menu modes include 'SHUFFLE' and 'REPEAT'.

Compact disc player

- 'SHUFFLE' options are 'OFF', 'FOL' which shuffles tracks in the current folder, and 'ALL' which plays all tracks on the disc in random order.
- 'REPEAT' options are 'ALL' which plays the entire disc and 'FOL' which plays all the tracks in current folder, then repeats tracks from the same folder.
- 'REPEAT' and 'SHUFFLE' functions are cancelled when a disc is ejected.

COMPACT DISC TRACK COMPRESSION

With this feature on, quieter music is boosted and louder music lowered to minimise repeated volume adjustments.

Sony CD/6CD

- Press the MENU button and use the up/down arrow buttons to select a 'COMP' display.
- Use the left/right arrow buttons to select 'COMP ON' or 'COMP OFF'.
- Press the MENU button to confirm your selection.
- Compression remains selected, unless it is switched off.

Except Sony CD/6CD

- Press MENU repeatedly until a 'COMP' display appears.
- Use the SEEK button to turn the function on or off.

COMPACT DISC TRACK SCANNING

The SCAN function allows you to preview each track for a few seconds.

Sony CD

When selected, the track being played flashes in the display. Scan playback continues until the SCAN button is pressed again.

- Press the SCAN button to scan each track on an Audio or MP3 CD.
- Press the SCAN button twice to scan the first track of each folder on an MP3 CD.

Sony 6CD

When selected, the track being played flashes in the display. Scan playback continues until the SCAN button is pressed again.

- Press the SCAN button to scan each track on an Audio CD.
- Press the SCAN button twice to scan each track on all Audio CDs loaded in the CD mechanism.

Except Sony CD/6CD

When selected, 'Scn' or 'SCAN' flash in the display.

Compact disc player

- Press the MENU button repeatedly until a 'SCAN' display appears.
- Use the SEEK button to scan up or down the tracks selected.
- Press SEEK again to continue listening to a track.

EJECTING COMPACT DISCS

Sony CD

- Press the eject button at any time and remove the disc.
- 'EJECTING' and 'PLEASE REMOVE' appear in the display.
- Radio reception is restored automatically when the eject button is pressed.
- If no CD is loaded when the eject button is pressed, 'NO CD' appears in the display.

When ejected, discs are held in the audio unit ready for removal. If they are not removed, the disc will be reloaded automatically.

Sony 6CD

- Press the eject button briefly, to eject the disc.
- 'PLEASE WAIT', 'EJECTING' and 'PLEASE REMOVE' appear in the display while a disc is being ejected.
- Playback resumes from the next available disc or, if no discs are inserted, 'NO CD' is displayed, and radio reception is restored as the eject button is pressed.

When ejected, discs are held in the audio unit ready for removal. If they are not removed, the disc will be reloaded automatically.

Except Sony CD/6CD

Single disc players

Press the eject button at any time and remove the disc.

6000 units with rocker volume control and 6000MP3 players

Press the CD/EJ button once during CD playback or twice during radio playback. Then remove the disc.

Multiple disc players

- During CD playback, press EJ to eject the disc being played or
- Use the preset button to select the disc you want to remove and then press EJ.

Note: If EJ is pressed in error, press the button again to cancel.

Compact disc player

'EJECT' and 'REMOVE' appear in the display and the disc is held ready for removal. If it is not removed, the disc will be pulled back into the audio unit and CD playback will restart.

After removal, 'INSERT' will be displayed briefly to allow a new disc to be inserted if required.

- To eject a disc during radio reception, press EJ.
- While 'SELECT' or 'SELECT CD' is displayed, press the preset button that corresponds to the disc to be ejected. 'REMOVE' appears in the display and the disc is held ready for removal.

UNLOADING THE COMPACT DISC CHANGER

- Slide open the door on the CD changer unit.
- Press the eject button and remove the magazine.
- Pull the tray out using the lever on the side.
- Remove the CD and close the tray.
- Repeat the last two steps to remove other CDs.

MP3 FILE PLAYBACK

6000MP3

When a compact disc is loaded into the 6000MP3 unit, the display will show 'READING' while the unit scans the disc. The time this takes will depend entirely on the number of tracks, files, folders and sessions on the disc. 'AUDIO CD', 'MP3 CD' or 'MIXED CD' will then be displayed to indicate the type of CD the unit detected.

If the disc is a mixed CD, the unit will automatically start playing the audio sections but you can switch to MP3 sessions by pressing and holding either of the folder navigation buttons.

To return to the audio tracks again, press and hold either of the folder navigation buttons.

MP3 navigation

MP3 tracks may be recorded on the CD in several ways. They can all be placed in the root directory like a conventional audio CD, or they can be placed in folders that may represent, for example, an album, an artist, or a genre. Folders may even be nested within other folders.

To cater for the latter requirement, the 6000MP3 unit has two additional buttons. Each has the folder legend (as in the Windows PC environment) and a direction arrow engraved on the face of it.

Compact disc player

When one of these buttons is pressed and released, the first track in the next or previous folder will be selected and played. The SEEK button (described above) can be used to move between tracks in the folder.

The normal playing sequence on CDs with multiple folders is to play the tracks in the first folder, then the tracks in any folder nested inside the first folder, then the second folder, and so forth.

Note: The unit will always play MP3 tracks in alphabetical order. If you record your own MP3 discs, and want to dictate a specific order of play, you must ensure that each track filename starts with a number, e.g. 001-sunshine-ladyb.mp3, 002-augustsong-robert.mp3, etc. The unit will still play in alphabetic sequence but the number will ensure that 001 is played before 002, and so forth.

Fast Trak selection

On the 6000MP3 unit, preset button 1 has an additional function when MP3 discs are being played. This allows you to step rapidly through the folders and tracks on the disc.

- Press button 1. 'FASTTRAK' appears in the display.
- Use the volume control to step through the tracks and folders by number until you find the song you want.
- Cancel the operation by pressing button 1 again or allow the operation to time out normally.

Note: When you use this method, only the folder and track numbers are displayed, i.e. F1 T4 followed by F1 T5, etc. To locate the track you want, you will need to know what folder it is in, and what track number it has.

Sony CD

MP3 (MPEG 1 Audio Layer-3) is a standard technology and format for compressing audio data. This allows a more efficient use of the media.

You can play MP3 files recorded on CD-ROMs, CD-Rs, and CD-RWs. The disc must be in the ISO 9660 level 1 or level 2 format, or Joliet or Romeo in the expansion format. You can also use a disc recorded in Multi Session.

ISO 9660 format

This is the most common international standard for the logical format of files and folders on a CD-ROM.

There are several specification levels. In Level 1, file names must be in the 8.3 format (no more than 8 characters in the name, no more than 3 characters in the extension ".MP3") and in capital letters.

Folder names can be no longer than 8 characters. There can be no more than 8 folder levels (trees). Level 2 specifications allow file names up to 31 characters long.

Each folder can have up to 8 trees.

Compact disc player

For Joliet or Romeo in the expansion format, please consider these restrictions when configuring your CD writing software.

Multi session

This is a recording method that enables adding of data using the Track-At-Once method.

Conventional CDs begin at a CD control area called the Lead-in and end at an area called Lead-out. A Multi Session CD is a CD having multiple sessions, with each segment from Lead-in to Lead-out regarded as a single session.

- CD-Extra: The format that records audio (audio CD data) as tracks on session 1, and records data as tracks on session 2.
- Mixed CD: In this format, data is recorded as track 1, and audio (audio CD data) is recorded as track 2.

File formats

- With formats other than ISO 9660 level 1 and level 2, folder names or file names may not be displayed correctly.
- When naming, be sure to add the file extension “.MP3” to the file name.

- If you put the extension “.MP3” to a file other than MP3, the unit cannot recognize the file properly and will generate random noise that could damage your speakers.
- The following discs take a longer time to start playback.
 - a disc recorded with complicated tree structure.
 - a disc recorded in Multi Session.
 - a non-finalised disc to which data can be added.

Playing a multi session disc

When the first track of the first session is audio CD data

Only audio CD data of the first session is played back. Non-audio CD data/MP3 file information (track number, time, etc.) is displayed with no sound.

When the first track of the first session is not audio CD data

- If an MP3 file is in the disc, only MP3 file(s) play back and other data is skipped. (Audio CD data is not recognised.)
- If no MP3 file is in the disc, nothing is played back. (Audio CD data is not recognised.)

MP3 files playback order

The playback order of the folders and files is as shown.

Note: A folder that does not include an MP3 file is skipped.

Compact disc player

Playback tip: To specify a desired playback order, before the folder or file name, input the order by number (e.g., "01," "02"), then record contents onto a disc. (The order differs depending on the writing software.)

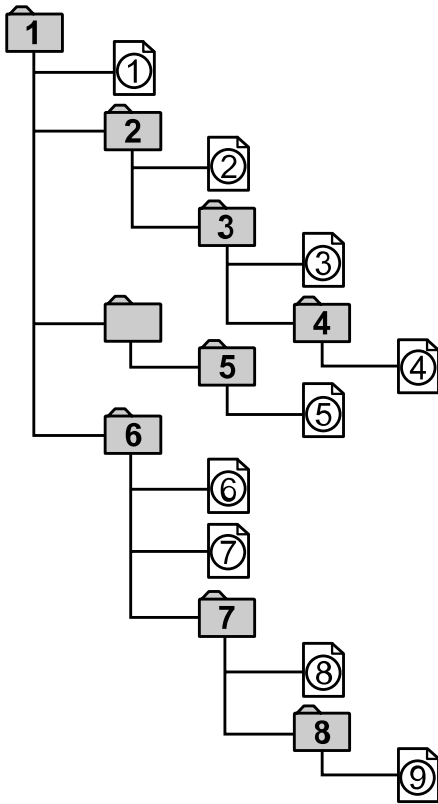

ID3 Tag Version 2

The following occurs when an MP3 file containing ID3 tag ver.2 is played:

- When skipping a portion of ID3 tag ver.2 (at the beginning of the track), sound is not output. Skip time changes depending ID3 tag ver.2 capacity. Example: At 64 kbytes, it is about 2 seconds (with RealJukebox).
- The displayed elapsed playing time when skipping a portion of ID3 tag ver.2 is inaccurate. For MP3 files of a bit rate other than 128 kbps, time is not displayed accurately during playback.
- When an MP3 file is created with MP3 conversion software (e.g. RealJukebox - a registered trademark of RealNetworks Inc), ID3 ver.2 will automatically be written.

MP3 navigation

MP3 tracks may be recorded on the CD in several ways. They can all be placed in the root directory like a conventional audio CD, or they can be placed in folders that may represent, for example, an album, an artist, or a genre.

The normal playing sequence on CDs with multiple folders is to play the tracks in the first folder, then the tracks in any folder(s) nested inside the first folder, then move onto the second folder, and so forth. For example, if folder 1 has folders 1a and 1b within it, and folder 2 contains folder 2a, the playing sequence will be folder 1, 1a, 1b, 2, 2a.

Compact disc player

- Press the up/down arrow buttons to select another folder.
- Press the left/right arrow buttons to select another track (file) within the folder.

MP3 DISPLAY OPTIONS

6000MP3

When an MP3 disc is playing, certain information encoded in each track can be displayed on the unit. Such information will normally include:

- The file name
- The folder name
- The song title
- The artist's name
- The name of the album from which the song was taken, if applicable
- The bit rate and sampling rate used for the recording

The unit will normally show the file name of the track that is playing. To select one of the other items of information, or to show the folder and track numbers:

- Press the INFO button repeatedly until the correct item is shown.
- After 2 seconds, the display will continue to show the selected information about the current song, or 'NO TEXT' if the info is unavailable. The display will scroll if necessary, and then revert to the standard filename (or other default) display.

MP3 default displays

You can also change the default display (normally file name) to another option of your choice:

- Press and hold the INFO button until 'DEFAULT INFO' is displayed.
- Use the volume control to scroll to the item of information you want to display as the default. Options are file name, song title, artist, album, or folder and track number.
- If the information you require is not encoded into a particular track, 'NO TEXT' will be displayed, and then the display will revert to the Folder and Track number display.

Scrolling MP3 displays

Normally the display will scroll once and then show only the first eight characters of whatever information you have chosen. However, it is possible to control how the display shows the information.

- Press and hold the MENU button for two seconds to access the Set-up menu.
- Press the MENU button repeatedly until 'SCROLL' appears in the display.
- Use the SEEK keys to select the option you require. Options are 'Off', 'Once' (1 – default setting), 'Twice' (2), and 'On'. 'On' will make the display scroll continuously.

Compact disc player

Sony CD unit

When an MP3 disc is playing, certain information encoded in each track can be displayed. Such information will normally include:

- The file name
- The folder name
- ID3 information which might be the album or artist's name

The unit will normally show the file name that is playing. To select one of the other items of information:

- Press the CD INFO button repeatedly until the display required is shown.
- If the ID3 information selected is unavailable, 'NO MP3 TAG' appears in the display.

Scrolling MP3 displays

Display information will scroll once across the display as each track starts, so the full line can be read. The display will then return to a static display showing the first few characters of whatever information you have chosen.

- Press the MENU button and use the up/down arrow buttons to select a 'SCROLL' display.
- Use the left/right arrow buttons to select 'SCROLL ON' or 'SCROLL OFF'. 'SCROLL ON' is the default setting and remains selected, unless it is switched off.

- Press the MENU button to confirm your selection.
- Press and hold the CD INFO button, to scroll the display independently of the scroll setting selected.

CD text display options

When an audio disc with CD text is playing, limited information encoded in each track can be displayed. Such information will normally include:

- The disc name
- The artist name
- The track name

These display options are selected in the same way as MP3 displays. 'NO DISC NAME' or 'NO TRACK NAME' appears if no information has been encoded.

REPEAT COMPACT DISC TRACKS

6500

- Press and hold the CD button to switch this function on or off.

Compact disc player

Sony CD

- Press the MENU button and use the up/down arrow buttons to select a 'REPEAT' display.
- Use the left/right arrow buttons to select 'REPEAT TRACK' or 'REPEAT OFF'.
- When an MP3 CD is playing, playback options are 'REPEAT TRACK', 'REP FOLDER' and 'REPEAT OFF'.

Press the MENU button to confirm your selection.

Sony 6CD

- Press the MENU button and use the up/down arrow buttons to select a 'REPEAT' display.
- Use the left/right arrow buttons to select 'REPEAT TRACK', 'REPEAT CD' or 'REPEAT OFF'.
- Repeat playback remains selected, unless it is switched off.

Press the MENU button to confirm your selection.

ENDING COMPACT DISC PLAYBACK

Sony CD/6CD

To restore radio reception on all units:

- Press the AM/FM button.

Note: This will not eject the CD; the disc will merely pause at the point where radio reception was restored. CD playback can be resumed by pressing the CD/AUX button again.

Except Sony CD/6CD

- Press the waveband button to restore radio reception.
- Push the tape control buttons partially in to restore tape playback.

On units fitted with an AMS button, this can also be used to restore tape operation.

Note: Neither of these actions will eject the CD; the disc will merely pause at the point where radio or tape reception was restored.

To resume CD playback, press the CD button again.

EJECTING MULTIPLE COMPACT DISCS

Sony 6CD

- Press and hold the eject button to eject all the discs that are loaded.
- 'EJECT ALL' followed by 'EJECTING' and 'PLEASE REMOVE' appear in the display, as each disc is ejected.
- When all discs have been ejected and removed, 'ALL CDs EMPTY' is displayed briefly and radio reception is restored.

Compact disc player

Except Sony 6CD

- To eject all discs, press and hold EJ until 'EJECT' or 'EJECT ALL' is displayed.
- The display will alternate between 'EJECT' and 'REMOVE'.
- When 'REMOVE' is displayed, take the disc out of the unit. This routine repeats until all discs have been removed.

Auxiliary input (AUX IN) socket

Where available, this socket is located in the vehicle glove box and permits an auxiliary device, like a portable MiniDisc or MP3 player, to be linked into the vehicle audio system, so that output can be played through the vehicle speakers.

To listen to an auxiliary device, plug it into the glove box socket using a 3.5 mm conventional 'headphone type' electrical connector.

Select the auxiliary input via the 'CD/AUX' button and playback will be heard through the vehicle speakers from that source, rather than from the vehicle audio unit. 'AUX' will appear in the vehicle audio unit display.

To disconnect the auxiliary device, pull out the plug-in electrical connector and use the vehicle audio unit buttons, 'CD/AUX', or 'FM/AM', to restore playback from the vehicle audio unit.

The vehicle audio unit buttons can also be used to restore playback from the vehicle audio unit, while the auxiliary device remains connected.

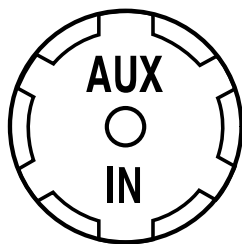

Rear passenger controls

REAR SEAT CONTROLS

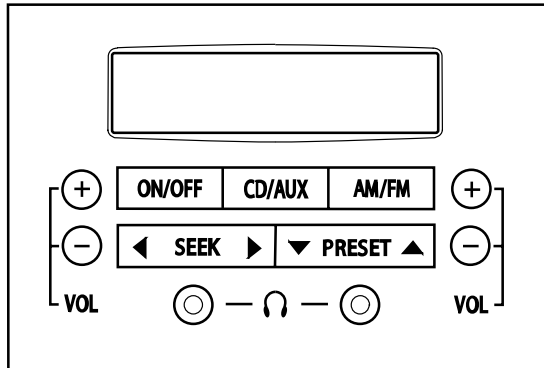

Where available, the way the Rear Seat Audio System control panel operates will depend on which RSE menu option is selected.

- Press the MENU button and use the up/down arrow buttons to select an RSE display.
- Use the left/right arrow buttons to select from 'RSE On, RSE Off, RSE Ctrl On or RSE Ctrl Off'.
- Press the MENU button to confirm your selection.

CONTROL PANEL BUTTONS

On/Off button

With 'RSE On/Rear Audio On' selected at the main audio unit

- Press the ON/OFF button on the Rear Seat Audio control panel to switch the system on or off and all the rear seat audio functions may then be controlled from the rear control panel.

With 'RSE Off/Rear Audio Off' selected at the main audio unit

- Pressing the ON/OFF button on the rear control panel will not affect the system. 'DISABLED' appears briefly in the display and the rear control panel will not operate.

Waveband selector

- Press this button repeatedly to select from FM1, FM2, FM AST, AM or AM AST. The display indicates the selection made.

Note: If the main audio unit and the rear control panel are tuned to radio reception when this button is pressed, 'SHARED' appears in the display to show that a shared radio source is being controlled through the main audio unit.

CD/AUX button

- Press this button repeatedly to select CD playback or playback from an auxiliary source like a mini disc player.

Note: If rear seat passengers select the same source as front seat passengers, 'SHARED' appears in the display to show that a shared CD source is being controlled through the main audio unit.

Rear passenger controls

Station preset/CD/MP3 folder selector

- Press this button repeatedly to select radio stations stored on the preset buttons, MP3 folders or discs from the magazine of a CD changer, when fitted.
- If the rear control panel is tuned to radio reception, press the up/down arrow buttons repeatedly to search through and select stations stored on the preset buttons for the waveband selected. The display shows which preset is selected and the waveband, e.g. 1FM1, 2FM1, 3FM1, etc.
- If CD playback from a CD changer is selected at the rear control panel, press the up/down arrow buttons repeatedly to search through and select discs in the magazine. The display indicates the selection.
- During playback from an MP3 CD, press the up/down arrow buttons repeatedly to search through and select from the file directories stored on the MP3 disc.

Seek button

If the rear control panel is tuned to radio reception:

- Press the left/right arrow buttons briefly for manual tuning, in small increments, down or up the waveband selected.
- Or press and hold the left/right arrow buttons for automatic tuning. The unit will stop at the first station it finds in the direction you have chosen.

If CD playback is selected at the rear control panel:

- Press the left/right arrow buttons briefly to select other tracks on the disc selected.
- Or press and hold the left/right arrow buttons to fast forward or fast reverse across the disc selected.

Note: If the main audio unit and rear control panel are used to select the same source when either the Station preset or Seek button is pressed, 'SHARED' appears in the display to show that a shared audio source is being controlled through the main audio unit.

CONTROL MODE

'RSE Ctrl On/Control Mode On'

Selecting 'RSE CTRL ON/CONTROL MODE ON' at the main audio unit will enable a front passenger to use the main audio unit to assist rear passengers to select a particular audio source, e.g. a radio station or a certain CD track.

Rear passenger controls

- Press the MENU button and use the up/down arrow buttons until an RSE display appears.
- Press the left/right arrow buttons to select from 'RSE Ctrl On'.
- Press the MENU button to confirm your selection.

Note: In this mode, all functions are controlled through the main audio unit and, if any rear control panel button is pressed, 'FRONT' appears in the rear panel display.

If 'RSE Ctrl On/Control Mode On' is selected, the main audio unit will provide playback from the audio source last selected in the rear compartment. 'RS' or 'RSE' are displayed on your audio unit display screen.

'RSE Ctrl Off/Control Mode Off'

Select 'RSE Ctrl Off/Control Mode Off' in a similar way to 'RSE Ctrl On/Control Mode On'.

With 'RSE Ctrl Off/Control Mode Off' selected, the main audio unit leaves RSE control mode and returns to the audio source being played before 'RSE Ctrl On/Control Mode On' was selected.

The rear audio system plays the source that was selected last in the RSE control mode.

ONE HOUR MODE

If the ignition is turned off or in the ACC position when the radio is turned off, pressing the ON/OFF button will switch on the system, but it switches off automatically, after one hour.

During this time, sound output will play through the vehicle's speaker system, if headphones are not plugged in, and this output is fully controlled through the Rear Seat Audio System control panel.

HEADPHONES

Volume control

Right headphone

- Press the right hand side + or – buttons repeatedly to increase or decrease sound output through headphones plugged into the right side socket.

Left headphone

- Press the left hand side + or – buttons repeatedly to increase or decrease sound output through headphones plugged into the left side socket.

HEADPHONE SOCKETS

If either or both headphone sockets are used, audio output mutes from the rear compartment audio system speakers, and is channeled, instead, through the fitted headphones.

Rear passenger controls

However, if the headphone sockets are used, audio output remains unaffected through the front compartment speakers and, in this way, front and rear seat passengers can listen to two different audio sources.

For example, with 'RSE On' selected, front seat passengers can insert a CD into the audio unit, and then press the AM/FM button to listen to radio reception through the front compartment audio system speakers.

At the same time, rear seat passengers using the rear seat audio system control panel, can press the CD/AUX button and listen to CD playback through their headphones.

At any time, front seat passengers can select the CD playback or rear seat passengers can switch to radio reception, without affecting audio output to the other part of the vehicle.

REAR PASSENGER CONTROL DISPLAY SCREEN

When the Rear Seat Audio System is switched on, the rear control panel display shows which audio source is selected for rear seat passengers.

- During radio reception, the preset button number, waveband and station frequency or station name are displayed.
- During CD playback, the CD track number and elapsed time appear.
- During playback from an MP3 disc, MP3, the CD track number and elapsed time appear.
- During playback from a CD changer, if fitted, the disc number, CD track number and elapsed time appear.
- The display also confirms volume adjustments made using the + or - control buttons.

If rear panel control functions are not available, information displays include:

- SHARED – This indicates the rear compartment audio source is shared with the main audio unit.
- FRONT – This shows that audio control is through the main audio unit.
- DISABLED – This shows that the rear seat audio system is not operating and cannot be switched on.

Audio system care

AUDIO UNIT

Cassette care

The tape head in the cassette player needs to be cleaned regularly with a recommended 'wet' cleaning tape to maintain the best sound quality.

Use high quality cassettes to improve sound performance and take good care of them. Avoid those that:

- are old, worn out, or spliced.
- are damaged or have a peeling label.
- have a total playback time exceeding 100 minutes. These use thinner tape that increases the chance of tangling.

CD care

For best possible sound quality, use CDs that are clean and in good condition.

Audio troubleshooting

Audio unit display	Rectification
E2E, E2D, E3, E5, E7, E11, E15, CD ERROR	Internal fault, see your Ford Dealer.
E12, E23, E24, E25, E26, E27, E28, E29, E2B, E2C, BAD CD	Clean the disc and try again.
E4	Disc upside down or dirty. Clean the disc and try again.
CD HOT, HIGH TEMP, E2, E14	Ambient temperature too hot – unit will not work until it has cooled down.
E16, E81, E84, E85	Eject fault, see your Ford Dealer.
CHECK CD	Disc loading or playback fault. Eject the disc, check it is clean and undamaged, and inserted correctly.
ERROR	Internal mechanical fault. CD playback will cease and the audio unit will revert to radio reception. See your Ford Dealer.
NON AUDIO CD	CD ROM/MP3 disc inserted.
NO TEXT	Information field not filled in.
TAPE ERR	Check cassette tape for faults.
NOT MP3	MP3 button pressed (e.g. folder up/down) when in non-MP3 mode.
WAIT	Radio is still waiting for information (e.g. when scanning an MP3 disc).

CD changer display	Rectification
CD/CDDJ ERROR, E5 CD DISC ERROR	Internal fault. See your Ford Dealer.
E2 or E3	Clean the disc and try again.
E4, CDDJ OVERHEAT	Ambient temperature too hot – unit will not work until it has cooled down.
NON AUDIO CD	CD ROM/MP3 disc inserted.
VIN ERROR	See your Ford Dealer.

Index

A

Alternative frequencies.....	22
2050.....	23
All other units except 2050.....	23
Sony CD/6CD.....	22
Audio control.....	15
Audio distortion reduction (CLIP).....	21
Audio introduction.....	3
Audio menu control.....	13
Audio system care.....	50
Audio system security.....	7
Audio troubleshooting.....	51
Audio unit clock and date displays.....	10
Audio unit menus.....	21
Audio unit operation.....	12
Audio unit overview.....	5
Audio unit.....	50
Cassette care.....	50
CD care.....	50
Auto reverse.....	28
Automatic music search (AMS).....	29
4050/5000 with a rotary volume control.....	29
5000 with a rocker volume control.....	29
5500.....	29
Automatic volume control (AVC).....	21
Autostore control.....	16
Auxiliary input (AUX IN) socket.....	45

B

Balance/fade control.....	12
Bass/treble control.....	12
Default audio settings.....	12

C

Cassette tape pause.....	28
2050.....	28
4000.....	28
4050, 5000 and 5000C.....	29
Cassette tape playback.....	27
Cassette tape player.....	27
Cassette tape side selection.....	29
Compact disc playback.....	32
Except Sony CD/6CD.....	32
Sony CD/6CD.....	32
Compact disc player.....	30
Compact disc selection.....	33
6006CDC.....	33
Sony 6CD.....	33
Compact disc track compression.....	35
Except Sony CD/6CD.....	35
Sony CD/6CD.....	35
Compact disc track scanning.....	35
Except Sony CD/6CD.....	35
Sony 6CD.....	35
Sony CD.....	35
Control mode.....	47
'RSE Ctrl Off/Control Mode Off'.....	48
'RSE Ctrl On/Control Mode On'.....	47
Control panel buttons.....	46
CD/AUX button.....	46
On/Off button.....	46
Seek button.....	47
Station preset/CD/MP3 folder selector.....	47
Waveband selector.....	46

D

Digital signal processing (DSP).....	21
--------------------------------------	----

Index

E

Ejecting a cassette tape.....	29
2050, 5000C and 5500.....	29
All other units except 5000C and 5500.....	29
Ejecting compact discs.....	36
Except Sony CD/6CD.....	36
Sony 6CD.....	36
Sony CD.....	36
Ejecting multiple compact discs	43
Except Sony 6CD.....	44
Sony 6CD.....	43
Ending compact disc playback.....	43
Except Sony CD/6CD.....	43
Sony CD/6CD.....	43
Ending playback.....	28
2050.....	28
On all units except 2050.....	28
Enhanced other network (RDS-EON).....	23
Entering a security code.....	7
2050.....	7
On all units except 2050.....	7

F

Fast forward/reverse.....	34
Fast forward.....	27
2050.....	27
5500.....	27
All other units except 2050.....	27
Fast rewind.....	27
2050.....	28
5500.....	28
All other units except 2050.....	28

H

Headphone sockets.....	48
------------------------	----

Headphones.....	48
Volume control.....	48

I

Important audio information.....	3
Disc labels.....	4
Sony CD/6CD.....	3
Incorrect security code.....	8
2050.....	8
On all units except 2050.....	8

L

Loading compact discs.....	30
6006.....	30
6500 and 6000CD.....	30
Sony 6CD.....	30
Sony CD.....	30
Loading the compact disc changer.....	31
Lost security code.....	7
Loudness control.....	20
6500.....	20

M

MP3 display options.....	41
6000MP3.....	41
Sony CD unit.....	42
MP3 file playback.....	37
6000MP3.....	37
Sony CD.....	38
Music/speech.....	23
5500/6500.....	23

N

News broadcasts.....	23
All other units except Sony CD/6CD and 2050.....	24
Sony CD/6CD.....	24

Index

O

- On/off control.....12
- 2050.....12
- One hour mode.....48

P

- Phone mute control.....13
- Preset scan tuning.....22
- Priority programme type (PTY).....24
- PTY selection during tape or CD playback.....26
- Selecting PTY.....26
- Selecting stations with different programme types.....26
- Selecting stations with the same programme type.....26
- Using PTY.....26

R

- Radio data system (RDS).....23
- Radio reception.....4
- Advanced digital filter adjustment (ADFA).....4
- Rear passenger control display screen.....49
- Rear passenger controls.....46
- Rear seat controls (RICP).....21
- Rear seat controls.....46
- Removable front panel.....7
-7
- Repeat compact disc tracks.....42
- 6500.....42
- Sony 6CD.....43
- Sony CD.....43

S

- Security code.....7

- Setting the clock and date on the audio unit.....10
- 2050.....10
- 5000C and 6000CD with centrally located on/off and volume control.....10
- Sony CD/6CD.....11
- Shuffle/random.....34
- Except Sony CD/6CD.....34
- Sony 6CD.....34
- Sony CD.....34
- Sound button.....16
- 2050 only.....16
- Bass/treble/balance and loudness.....16
- Sound style.....16
- Station preset buttons.....15
- Station tuning control.....19
- Manual tuning.....19
- Scan tuning.....19
- Seek tuning.....19
- Stereo indicator control.....17
- 2050.....17
- On all units except 2050.....17

T

- Track selection.....31
- Except Sony CD/6CD.....32
- Sony CD/6CD.....31
- Traffic information (TA) control.....17
- Activating traffic announcements.....17
- Ending traffic announcements.....19
- Local or distant traffic.....18
- Traffic announcement volume.....18

U

- Unloading the compact disc changer.....37

Index

V

Vehicle identification (VID).....	8
On all units except 2050.....	8
Volume control.....	12

W

Waveband button.....	16
----------------------	----

