

**Ford**Fiesta  
Owner's handbook

Feel the difference



The information contained in this publication was correct at the time of going to print. In the interest of development the right is reserved to change specifications, design or equipment at any time without notice and without incurring any obligations. This publication, or part thereof, may not be reproduced nor translated without our approval. Errors and omissions excepted.

© Ford Motor Company 2010

All rights reserved.

Part number: (CG3545en) 10/2010 20101125075351



# Table of contents

---

## Introduction

About this handbook.....	7
Symbols glossary.....	7
Parts and accessories.....	7

## Quick start

Quick start.....	10
------------------	----

## Child safety

Child seats.....	19
Child seat positioning.....	20
Booster cushions.....	22
ISOFIX anchor points.....	23
Child safety locks.....	24

## Occupant protection

Principle of operation.....	25
Fastening the seat belts.....	27
Seat belt height adjustment.....	28
Seat belt reminder.....	28
Using seat belts during pregnancy.....	28
Disabling the passenger airbag.....	29

## Keys and remote controls

General information on radio frequencies.....	30
Programming the remote control.....	30
Changing the remote control battery.....	30

## Locks

Locking and unlocking.....	34
Keyless entry.....	36

## Engine immobiliser

Principle of operation.....	39
Coded keys.....	39
Arming the engine immobiliser.....	39
Disarming the engine immobiliser.....	39

## Alarm

Principle of operation.....	40
Arming the alarm.....	40
Disarming the alarm.....	40

## Steering wheel

Adjusting the steering wheel.....	41
Audio control.....	41
Voice control.....	42

## Wipers and washers

Windscreen wipers.....	43
Autowipers.....	43
Windscreen washers.....	44
Rear window wiper and washers.....	44
Adjusting the windscreen washer jets.....	45
Checking the wiper blades.....	45
Changing the wiper blades.....	46

## Lighting

Lighting control.....	47
Autolamps.....	48
Front fog lamps.....	48
Rear fog lamps.....	48
Headlamp levelling.....	48
Hazard warning flashers.....	49
Direction indicators.....	49
Interior lamps.....	49
Removing a headlamp.....	50
Changing a bulb.....	50
Bulb specification chart.....	55

## Windows and mirrors

Electric windows.....	56
Exterior mirrors.....	57
Electric exterior mirrors.....	57
Auto-dimming mirror.....	58

# Table of contents

---

## Instruments

Gauges.....	59
Warning lamps and indicators.....	59
Audible warnings and indicators.....	62

## Information displays

General information.....	64
Trip computer.....	69
Personalised settings.....	69
Information messages.....	70

## Climate control

Principle of operation.....	75
Air vents.....	75
Manual climate control.....	76
Automatic climate control.....	78
Heated windows and mirrors.....	80

## Seats

Sitting in the correct position.....	81
Head restraints.....	81
Manual seats.....	82
Rear seats.....	84
Heated seats.....	84

## Convenience features

Sun visors.....	85
Clock.....	85
Cup holders.....	85
Cigar lighter.....	85
Storage compartments.....	85
Map pockets.....	86
Toll reader.....	86
Auxiliary input (AUX IN) socket.....	86
USB port.....	87
Satellite navigation unit holder.....	87
Floor mats.....	87

## Starting the engine

General information.....	88
Ignition switch.....	88
Keyless starting.....	88
Steering wheel lock.....	90
Starting a petrol engine.....	90
Starting a diesel engine.....	91
Diesel particulate filter (DPF).....	91

## Fuel and refuelling

Safety precautions.....	93
Fuel quality - Petrol.....	93
Fuel quality - Diesel.....	93
Fuel filler flap.....	93
Catalytic converter.....	94
Refuelling.....	95
Fuel consumption.....	95
Technical specifications.....	95

## Transmission

Manual transmission.....	97
Automatic transmission.....	97

## Brakes

Principle of operation.....	100
Hints on driving with ABS.....	100
Parking brake.....	100

## Stability control

Principle of operation.....	101
Using stability control.....	101

## Parking aid

Principle of operation.....	102
Using the parking aid - Vehicles With: Rear Parking Aid.....	102
Using the parking aid - Vehicles With: Front and Rear Parking Aid.....	103

# Table of contents

---

## Rear view camera

Principle of operation.....	104
Using the rear view camera.....	104

## Cruise control

Principle of operation.....	106
Using cruise control.....	106

## Load carrying

General information.....	108
Luggage covers.....	108
Roof racks and load carriers.....	108

## Towing

Towing a trailer.....	109
Detachable tow ball.....	109

## Driving hints

Running-in.....	113
Cold weather precautions.....	113
Driving through water.....	113

## Emergency equipment

First aid kit.....	114
Warning triangle.....	114

## Fuses

Fuse box locations.....	115
Changing a fuse.....	115
Fuse specification chart.....	116

## Vehicle recovery

Towing points.....	125
Towing the vehicle on four wheels.....	125

## Maintenance

General information.....	127
Opening and closing the bonnet.....	128

Engine compartment overview - 1.25L Duratec-16V (Sigma)/1.4L Duratec-16V (Sigma)/1.6L Duratec-16V Ti-VCT (Sigma).....	129
---	-----

Engine compartment overview - 1.4L Duratorq-TDCi (DV) Diesel.....	130
---	-----

Engine compartment overview - 1.6L Duratorq-TDCi (DV) Diesel.....	131
---	-----

Engine oil dipstick - 1.25L Duratec-16V (Sigma)/1.4L Duratec-16V (Sigma)/1.6L Duratec-16V Ti-VCT (Sigma).....	132
---	-----

Engine oil dipstick - 1.4L Duratorq-TDCi (DV) Diesel/1.6L Duratorq-TDCi (DV) Diesel.....	132
--	-----

Engine oil check.....	133
-----------------------	-----

Engine coolant check.....	133
---------------------------	-----

Washer fluid check.....	134
-------------------------	-----

Brake and clutch fluid check.....	134
-----------------------------------	-----

Technical specifications.....	135
-------------------------------	-----

## Vehicle care

Cleaning the exterior.....	137
----------------------------	-----

Cleaning the interior.....	137
----------------------------	-----

Repairing minor paint damage.....	138
-----------------------------------	-----

## Vehicle battery

Using booster cables.....	139
---------------------------	-----

Battery connection points.....	140
--------------------------------	-----

## Wheels and tyres

General information.....	141
--------------------------	-----

Changing a road wheel.....	141
----------------------------	-----

Tyre repair kit.....	146
----------------------	-----

Tyre care.....	149
----------------	-----

Using winter tyres.....	150
-------------------------	-----

Using snow chains.....	150
------------------------	-----

Technical specifications.....	150
-------------------------------	-----

## Vehicle identification

Vehicle identification plate.....	154
-----------------------------------	-----

Vehicle identification number (VIN).....	154
--	-----

# Table of contents

---

## Technical specifications

Technical specifications.....155

## Audio introduction

Important audio information.....159

## Audio unit overview

Audio unit overview.....160

## Audio system security

Security code.....166

## Audio unit operation

On/off control.....167

Sound button.....167

Waveband button.....167

Station tuning control.....167

Station preset buttons.....168

Autostore control.....168

Traffic information control.....168

## Audio unit menus

Automatic volume control.....170

Digital signal processing (DSP).....170

News broadcasts.....170

Alternative frequencies.....170

Regional mode (REG).....171

## Compact disc player

Compact disc playback.....172

Track selection.....172

Fast forward/reverse.....172

Shuffle/random.....172

Repeat compact disc tracks.....172

Compact disc track scanning.....173

MP3 file playback.....173

MP3 display options.....175

Ending compact disc playback.....175

## Auxiliary input (AUX IN) socket

Auxiliary input (AUX IN) socket.....176

## Audio troubleshooting

Audio troubleshooting.....177

## Telephone

General information.....178

Bluetooth setup.....178

Telephone setup.....178

Telephone controls.....179

Using the telephone.....179

## Voice control

Principle of operation.....182

Using voice control.....182

Audio unit commands.....183

Telephone commands.....190

Climate control commands.....195

## Connectivity

General information.....198

Connecting an external device.....199

Connecting an external device -  
Vehicles With: Bluetooth.....199

Using a USB device.....200

Using an iPod.....201

## Navigation introduction

Road Safety.....203

## Navigation system

Getting started.....204

## Appendices

Type approvals.....206

Type approvals.....206

Type approvals.....206

# Table of contents

---

Electromagnetic compatibility.....207



# Introduction

## ABOUT THIS HANDBOOK

Thank you for choosing Ford. We recommend that you take some time to get to know your vehicle by reading this handbook. The more that you know about it, the greater the safety and pleasure you will get from driving it.

### WARNING



Always drive with due care and attention when using and operating the controls and features on your vehicle.

**Note:** This handbook describes product features and options available throughout the range, sometimes even before they are generally available. It may describe options not fitted to your vehicle.

**Note:** Some of the illustrations in this handbook may be used for different models, so may appear different to your vehicle. However, the essential information in the illustrations is always correct.

**Note:** Always use and operate your vehicle in line with all applicable laws and regulations.

**Note:** Pass on this handbook when selling your vehicle. It is an integral part of the vehicle.

This vehicle has received the endorsement of TÜV, the accredited international testing organisation, for its allergy-friendly properties.

All materials used in the manufacture of the interior of this vehicle meet strict requirements of the TÜV TOXPROOF Criteria Catalogue for Vehicle Interiors by TÜV Produkt and Umwelt GmbH and are designed to minimize the risk of allergic reactions.

Additionally an efficient pollen filter protects the passengers against allergen particles in the outdoor air.

For more information, contact TÜV at [www.tuv.com](http://www.tuv.com).

## SYMBOLS GLOSSARY

### Symbols in this handbook

#### WARNING



You risk death or serious injury to yourself and others if you do not follow the instructions highlighted by the warning symbol.

#### CAUTION



You risk damaging your vehicle if you do not follow the instructions highlighted by the caution symbol.

### Symbols on your vehicle



When you see these symbols, read and follow the relevant instructions in this handbook before touching or attempting adjustment of any kind.

## PARTS AND ACCESSORIES

### Now you can be sure that your Ford parts are Ford parts

Your Ford has been built to the highest standards using high quality Ford Original Parts. As a result, you can enjoy driving it for many years.

# Introduction

---

Should the unexpected occur and a major part needs replacing, we recommend that you accept nothing less than Ford Original Parts.

The use of Ford Original Parts ensures that your vehicle is repaired to its pre-accident condition and maintains its maximum residual value.

Ford Original Parts match Ford's stringent safety requirements and high standards of fit, finish and reliability. Quite simply, they represent the best overall repair value, including parts and labour costs.

Now it is easier to tell if you have really been given Ford Original Parts. The Ford logo is clearly visible on the following parts if they are Ford Original Parts. If your vehicle has to be repaired, look for the clearly visible Ford branding and make sure that only Ford Original Parts have been used.

## Look for the Ford logo on the following parts

### Sheet metal

- Bonnet
- Wing
- Doors
- Luggage compartment lid



E102435

### Bumper and radiator grille

- Radiator grille
- Front and rear bumper

# Introduction



E102436

## Exterior mirror



E102437

## Glass

- Rear window
- Side glass
- Windscreen



E89939

## Lighting

- Rear lamps
- Headlamp

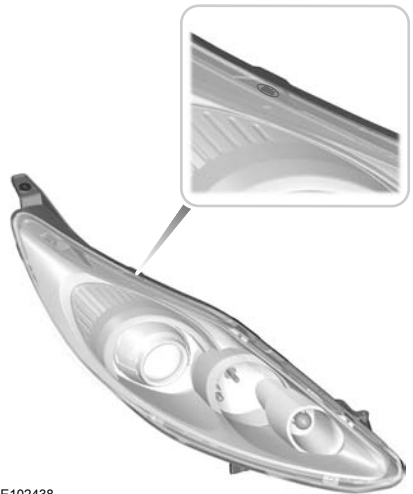

E102438

# Quick start

## QUICK START

### Instrument panel overview

Left-hand drive

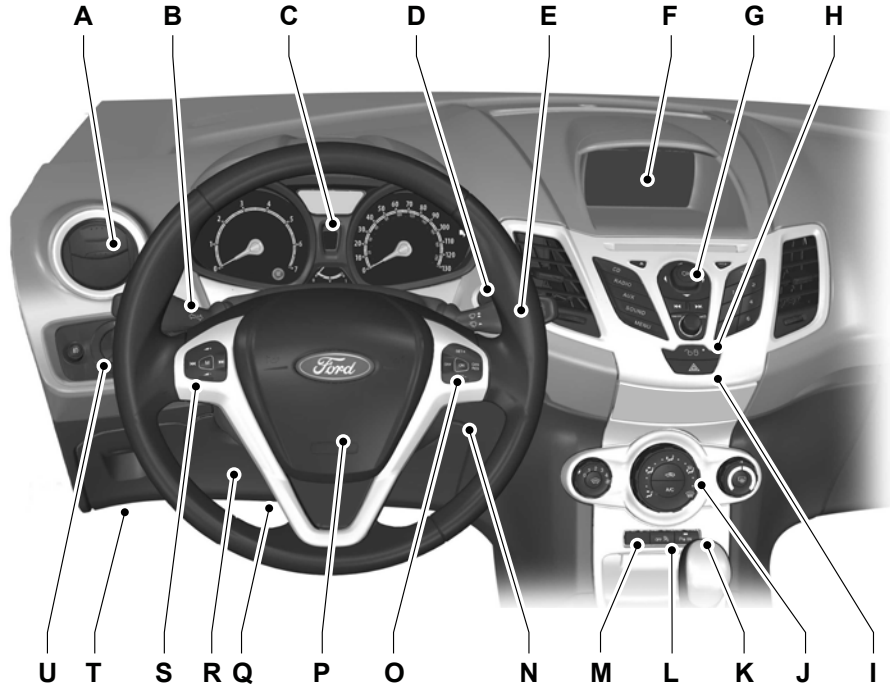

E102562

# Quick start

## Right-hand drive

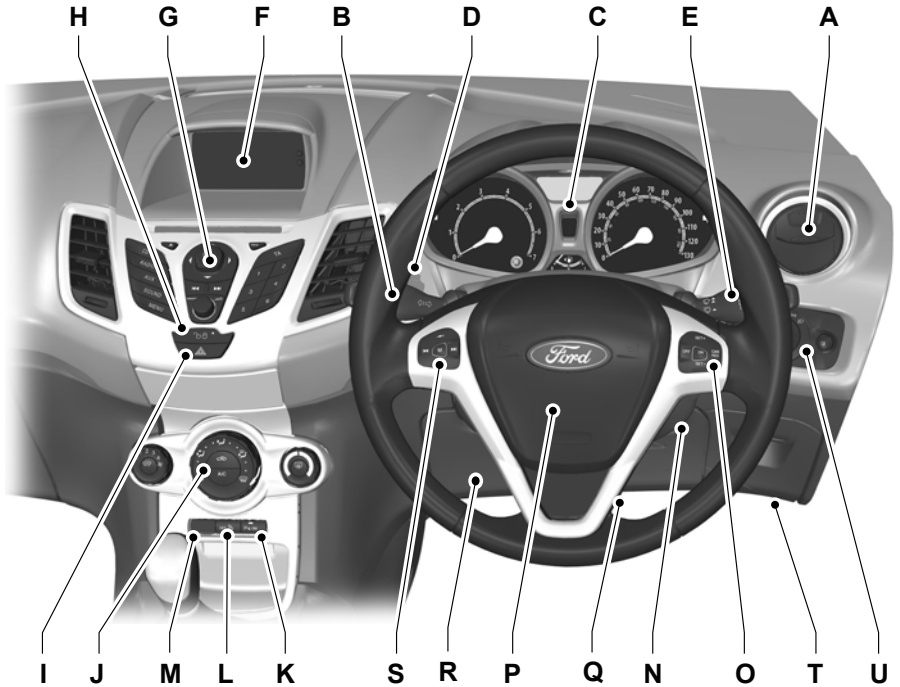

E102559

- A Air vents. See **Air vents** (page 75).
- B Multi-function lever: Direction indicators. See **Direction indicators** (page 49). Main beam. See **Lighting control** (page 47). See **Voice control** (page 42). See **Trip computer** (page 69).
- C Instrument cluster. See **Gauges** (page 59). See **Warning lamps and indicators** (page 59).
- D Start button. See **Keyless starting** (page 88).
- E Wiper lever. See **Wipers and washers** (page 43).
- F Multi functional display.
- G Audio unit. See **Audio unit overview** (page 160).

## Quick start

- H Door lock button. See **Locking and unlocking** (page 34).
- I Hazard warning flasher switch. See **Hazard warning flashers** (page 49).
- J Climate controls. See **Climate control** (page 75).
- K Card holder, or Parking aid warning lamp or switch. See **Parking aid** (page 102).
- L Card holder, or Passenger airbag deactivation warning lamp. See **Disabling the passenger airbag** (page 29).
- M Stability control (ESP) switch. See **Using stability control** (page 101).
- N Ignition switch.
- O Cruise control. See **Using cruise control** (page 106).
- P Horn.
- Q Steering wheel adjustment. See **Adjusting the steering wheel** (page 41).
- R Driver knee airbag. See **Principle of operation** (page 25).
- S Audio control. See **Audio control** (page 41).
- T Bonnet release lever. See **Opening and closing the bonnet** (page 128).
- U Lighting control. See **Lighting control** (page 47). Front fog lamps. See **Front fog lamps** (page 48). Rear fog lamp. See **Rear fog lamps** (page 48).

# Quick start

## Locking and unlocking

### Unlocking the vehicle

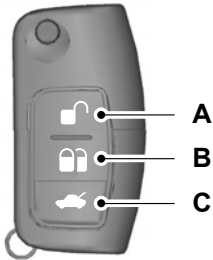

E71963

- A Unlock
- B Lock
- C Luggage compartment lid unlock

Press the unlock button once to unlock the vehicle. See **Programming the remote control** (page 30).

Press the lock button once to activate central locking.

Press the lock button twice within three seconds to activate double locking.

Press the luggage compartment lid unlock button twice within three seconds to unlock the luggage compartment.

See **Locking and unlocking** (page 34).

## Keyless entry

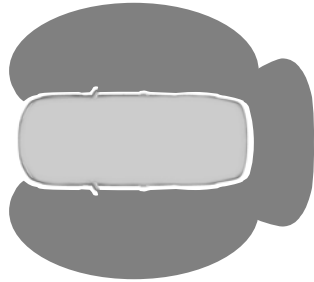

E78276

Passive locking and unlocking requires a valid passive key to be located within one of the three external detection ranges.

## Locking the vehicle

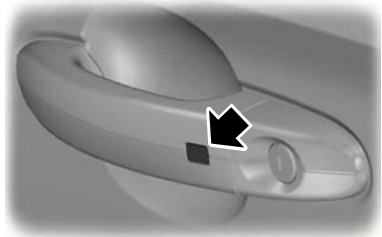

E87384

Locking buttons are located on each of the front doors.

Press a locking button once.

# Quick start

## Unlocking the vehicle

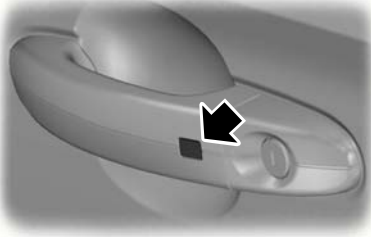

E87384

Press a locking button once.

See **Keyless entry** (page 36).

## Keyless starting



E85766

Press the start button once.

## Starting with automatic transmission

**Note:** Releasing the brake pedal during engine start will stop the engine cranking and return to ignition on.

1. Make sure the transmission is in **P** or **N**.
2. Fully depress the brake pedal.
3. Briefly press the start button.

## Starting with manual transmission

**Note:** Releasing the clutch pedal during engine start will stop the engine cranking and return to ignition on.

1. Fully depress the clutch pedal.
2. Briefly press the start button.

See **Keyless starting** (page 88).

## Adjusting the steering wheel

### WARNING



Never adjust the steering wheel when the vehicle is moving.

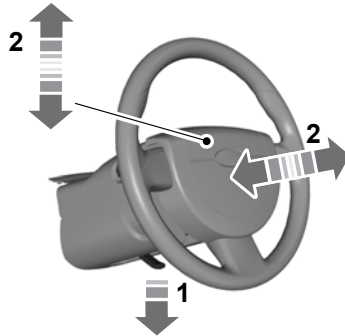

E95178

### WARNING



Make sure that you fully engage the locking lever when returning it to its original position.

# Quick start



E95179

See **Adjusting the steering wheel** (page 41).

## Manual climate control

### Recommended settings for cooling

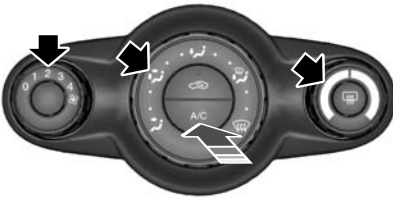

E112145

Open the centre and side air vents.  
Direct the centre air vents upwards and the side air vents toward the side windows.

## Recommended settings for heating



E112146

Close the centre air vents and open the side air vents.

Direct the side air vents toward the side windows.

See **Manual climate control** (page 76).

## Automatic climate control

### Recommended settings for cooling



E112147

Set the temperature to 22°C (72°F).  
Open the centre and side air vents.  
Direct the centre air vents upwards and the side air vents toward the side windows.

# Quick start

## Recommended settings for heating



E112148

Set the temperature to 22°C (72°F).  
Open the centre and side air vents.  
Direct the centre air vents upwards and the side air vents toward the side windows.

See **Automatic climate control** (page 78).

## Autolamps

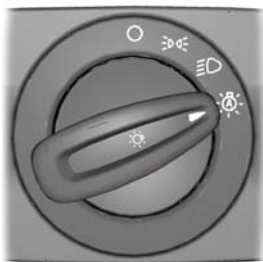

E70719

The headlamps will come on and go off automatically depending on the ambient light.

See **Lighting control** (page 47).

## Direction indicators



E102016

If the lever is tapped up or down, the direction indicators will flash three times.

See **Direction indicators** (page 49).

## Autowipers



E102034

Move the lever up one position.

The rain sensor will continuously measure the amount of water on the windscreen and adjust the speed of the front wipers automatically.

Adjust the sensitivity of the rain sensor using the rotary control.

See **Windscreen wipers** (page 43).

# Quick start

## Airbag



E69213

### WARNING

 To avoid the risk of death or serious injury, never use a rearward facing child restraint in the front, unless the air bag is off.

See **Child safety** (page 19).

See **Disabling the passenger airbag** (page 29).

## Manual seats

**Note:** Do not hold on to the locking lever when moving the seat.

To move the seat, follow the sequence shown.

## Folding the seatback forwards - 3-door

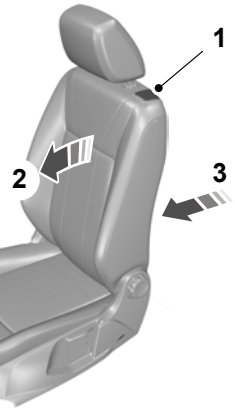

E112675

## Returning the seatback to the seating position - 3-door

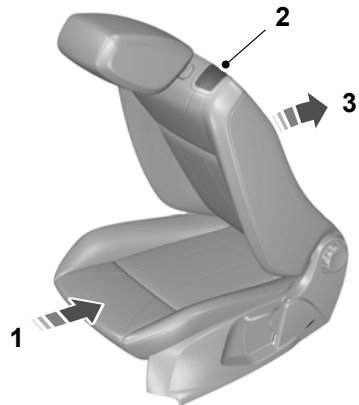

E112676

See **Manual seats** (page 82).

# Quick start

## Fuel filler flap

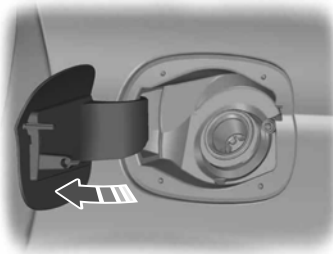

E103203

Press the flap to open it. Open the flap fully until it engages.

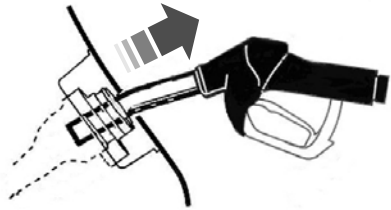

E119081

Slightly raise the fuel nozzle to remove it.

See **Fuel filler flap** (page 93).

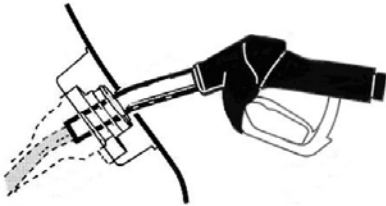

E119080

Insert the fuel nozzle up to and including the first notch on the nozzle. Keep it resting on the cover of the fuel pipe opening.

### WARNING



We recommend that you wait at least 10 seconds before removing the fuel nozzle to allow any residual fuel to drain into the fuel tank.

# Child safety

## CHILD SEATS







E133140





E68916

### WARNINGS

-  Secure children that are less than 150 centimetres tall in a suitable, government approved child restraint, in the rear seat
-  Extreme Hazard! Do not use a rearward facing child restraint on a seat protected by an air bag in front of it!
-  Read and follow the manufacturer's instructions when you are fitting a child restraint.
-  Do not modify child restraints in any way.
-  Do not hold a child on your lap when the vehicle is moving.

### WARNINGS

-  Do not leave unattended children in your vehicle.
-  If your vehicle has been involved in an accident, have the child restraints checked by properly trained technicians.

**Note:** *Mandatory use of child restraints varies from country to country.*

Only child restraints certified to ECE-R44.03 (or later) have been tested and approved for use in your vehicle. A choice of these are available from your Dealer.

### Child restraints for different mass groups

Use the correct child restraint as follows:

#### Baby safety seat



E68918

Secure children that weigh less than 13 kilograms in a rearward facing baby safety seat (Group 0+) in the rear seat.

# Child safety

## Child safety seat



E68920



Secure children that weigh between 13 and 18 kilograms in a child safety seat (Group 1) in the rear seat

## CHILD SEAT POSITIONING

### WARNINGS

 Please consult your Dealer for the latest details relating to Ford recommended child seats.

### WARNINGS

-  Original text according to ECE R94.01: Extreme Hazard! Do not use a rearward facing child restraint on a seat protected by an air bag in front of it!
-  When using a child seat with a support leg, the support leg must rest securely on the floor.
-  When using a child seat with a seat belt, make sure that the seat belt is not slack or twisted.

### CAUTION

 The child seat must rest tightly against the vehicle seat. It may be necessary to lift or remove the head restraint. See **Head restraints** (page 81).

**Note:** *When using a child seat on a front seat, always adjust the front passenger seat to its fully rearwards position. If it proves difficult to tighten the lap section of the seat belt without slack remaining, adjust the seatback to the fully upright position and raise the height of the seat. See **Seats** (page 81).*

Seating positions	Mass group categories				
	0	0+	1	2	3
	Up to 10 kg	Up to 13 kg	9 - 18 kg	15 - 25 kg	22 - 36 kg
Front passenger seat with airbag <b>ON</b>	X	X	UF <sup>1</sup>	UF <sup>1</sup>	UF <sup>1</sup>
Front passenger seat with airbag <b>OFF</b>	U <sup>1</sup>	U <sup>1</sup>	U <sup>1</sup>	U <sup>1</sup>	U <sup>1</sup>
Rear seats	U	U	U	U	U

**X** Not suitable for children in this mass group.

**U** Suitable for universal category child seats approved for use in this mass group.

# Child safety

**U<sup>1</sup>** Suitable for universal category child seats approved for use in this mass group. However, we recommend that you secure children in a government approved child seat, in the rear seat.

**UF<sup>1</sup>** Suitable for universal category forward facing child seats approved for use in this mass group. However, we recommend that you secure children in a government approved child seat, in the rear seat.

## ISOFIX child seats

Seating positions		Mass group categories	
		O+	1
		Rear facing	Forward facing
		Up to 13 kg	9 - 18 kg
Front seat	Size class	Not ISOFIX equipped	
	Seat type		
Rear outboard seat ISOFIX	Size class	E*	B, B1*
	Seat type	IL**	IL, IUF***
Rear centre seat	Size class	Not ISOFIX equipped	
	Seat type		

**IL** Suitable for particular ISOFIX child restraints systems of the **semi-universal** category. Please consult child restraints systems suppliers' vehicle recommendation lists.

**IUF** Suitable for ISOFIX forward facing child restraints systems of **universal** category approved for use in this mass group and ISOFIX size class.

\* The ISOFIX size class for both **universal** and **semi-universal** child restraints systems is defined by the capital letters **A** to **G**. These identification letters are displayed on ISOFIX child restraints.







\*\* At time of publishing the recommended Group O+ ISOFIX baby safety seat is the Britax Romer Baby Safe. Please consult your Dealer for the latest details relating to Ford recommended child seats.

\*\*\* At time of publishing the recommended Group 1 ISOFIX child seat is the Britax Romer Duo. Please consult your Dealer for the latest details relating to Ford recommended child seats.

# Child safety

## BOOSTER CUSHIONS

### WARNINGS

-  Do not install a booster seat or a booster cushion with only the lap strap of the seat belt.
-  Do not install a booster seat or a booster cushion with a seat belt that is slack or twisted.
-  Do not put the seat belt under your child's arm or behind its back.
-  Do not use pillows, books or towels to boost your child's height.
-  Make sure that your children sit in an upright position.
-  Secure children that weigh more than 15 kilograms but are less than 150 centimetres tall in a booster seat or a booster cushion.

### CAUTION

-  When using a child seat on a rear seat, make sure that the child seat rests tightly against the vehicle seat. It may be necessary to lift or remove the head restraint. See **Head restraints** (page 81).

## Booster seat (Group 2)



E70710

We recommend that you use a booster seat that combines a cushion with a backrest instead of a booster cushion only. The raised seating position will allow you to position the shoulder strap of the adult seat belt over the centre of your child's shoulder and the lap strap tightly across its hips.

## Booster cushion (Group 3)



E68924

# Child safety

## ISOFIX ANCHOR POINTS

### WARNING

 Use an anti-rotation device when using the ISOFIX system. We recommend the use of a top tether or support leg.

Your vehicle is fitted with ISOFIX anchor points that accommodate universally approved ISOFIX child seats.

The ISOFIX system comprises of two rigid attachment arms on the child seat that attach to anchor points on the outboard rear seats, where the cushion and backrest meet. Tether anchor points are fitted behind the outboard rear seats for child seats with a top tether.

### Top tether anchor points

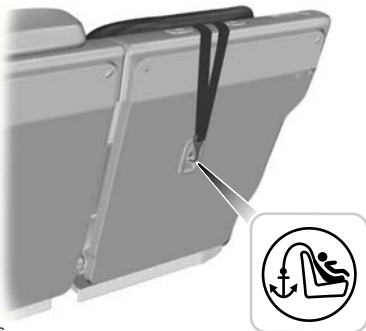

E87146

### Attaching a child seat with top tethers

### WARNING

 Do not attach a tether strap to anything other than the correct tether anchor point.

**Note:** Where applicable, remove the luggage cover to ease installation. See **Luggage covers** (page 108).

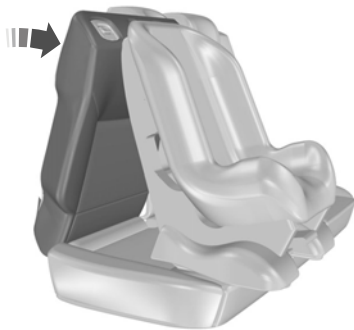

E87591

1. Place the child seat on the back seat cushion and fold the relevant seatback forwards. See **Rear seats** (page 84).
2. Remove the head restraint. See **Head restraints** (page 81).

### WARNING

 Make sure the top tether strap is not slack or twisted and is properly located on the anchor point.

3. Route the tether strap to the anchor point.

### WARNING

 Make sure that the seatback is secure and fully engaged in the catch.

4. Push the seatback to the upright position.

# Child safety



E87145

5. Push the child seat back firmly to engage the ISOFIX lower anchor points.
6. Tighten the tether strap in line with the child seat manufacturer's instructions.

## CHILD SAFETY LOCKS

### WARNING



You cannot open the doors from inside if you have put the child safety locks on.



E112197

### Left-hand side

Turn anti-clockwise to lock and clockwise to unlock.

### Right-hand side

Turn clockwise to lock and anti-clockwise to unlock.

# Occupant protection

## PRINCIPLE OF OPERATION

### Airbags

#### WARNINGS



Do not modify the front of your vehicle in any way. This could adversely affect deployment of the airbags.



Original text according to ECE R94.01: Extreme Hazard! Do not use a rearward facing child restraint on a seat protected by an airbag in front of it!



Wear a seat belt and keep sufficient distance between yourself and the steering wheel. Only when you use the seat belt properly, can it hold you in a position that allows the airbag to achieve its optimum effect. See **Sitting in the correct position** (page 81).



Have repairs to the steering wheel, steering column, seats, airbags and seat belts carried out by a properly trained technician.



Keep the areas in front of the airbags free from obstruction. Do not affix anything to or over the airbag covers.



Do not poke sharp objects into areas where airbags are fitted. This could damage and adversely affect deployment of the airbags.



Use seat covers designed for seats with side airbags. Have these fitted by a properly trained technician.

**Note:** You will hear a loud bang and see a cloud of harmless powdery residue if an airbag deploys. This is normal.

**Note:** Only wipe airbag covers with a damp cloth.

### Driver and front passenger airbags

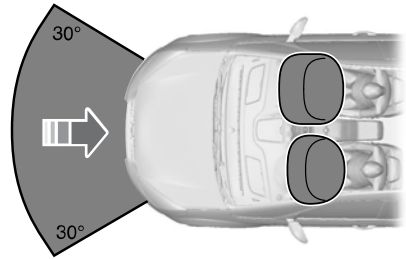

E74302

The driver and front passenger airbags will deploy during significant frontal collisions or collisions that are up to 30 degrees from the left or the right. The airbags will inflate within a few thousandths of a second and deflate on contact with the occupants, thus cushioning forward body movement. During minor frontal collisions, overturns, rear collisions and side collisions, the driver and front passenger airbags will not deploy.

### Driver knee airbag

#### CAUTION



Do not attempt to open the driver knee airbag cover.

The driver knee airbag will deploy during frontal collisions or collisions that are up to 30 degrees from the left or the right. The airbag will inflate within a few thousandths of a second and deflate on contact with the occupants, thus providing a cushion between the driver's knees and the steering column. During overturns, rear collisions and side collisions, the knee airbag will not deploy. For item location: See **Quick start** (page 10).

# Occupant protection

**Note:** The knee airbag has a lower deployment threshold than the front airbags. During a minor collision, it is possible that only the knee airbag deploys.

## Side airbags



E72658

Side airbags are fitted inside the seatback of the front seats. A label indicates that side airbags are fitted to your vehicle.

The side airbags will deploy during significant lateral collisions. The airbags will inflate within a few thousandths of a second and deflate on contact with the occupants, thus providing protection for the chest and shoulder areas. During minor lateral collisions, overturns, front collisions and rear collisions, the side airbags will not deploy.

## Curtain airbags

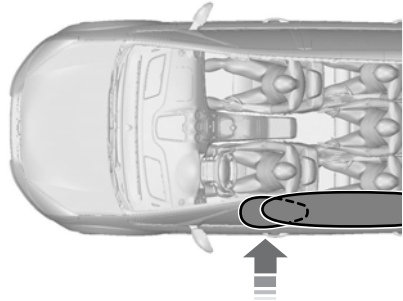

E75004

Curtain airbags are fitted inside the trim panels over the front and rear side windows. Moulded badges in the B-pillar trim panels indicate that curtain airbags are fitted to your vehicle.

The curtain airbags will deploy during significant lateral collisions. The airbag will inflate within a few thousandths of a second and deflate on contact with the occupants, thus providing protection for the head. During minor lateral collisions, front collisions, rear collisions, or overturns the curtain airbags will not deploy.

## Seat belts

### WARNINGS



Wear a seat belt and keep sufficient distance between yourself and the steering wheel. Only when you use the seat belt properly, can it hold you in a position to achieve its optimum effect. See **Sitting in the correct position** (page 81).





Never use a seat belt for more than one person.



Use the correct buckle for each seat belt.

# Occupant protection

## WARNINGS

-  Do not use a seat belt that is slack or twisted.
-  Do not wear thick clothing. The seat belt must fit tightly around your body to achieve its optimum effect.
-  Position the shoulder strap of the seat belt over the centre of your shoulder and position the lap strap tightly across your hips.

The driver and front passenger seat belt retractors are fitted with a seat belt pretensioner. Seat belt pretensioners have a lower deployment threshold than the airbags. During minor collisions, it is possible that only the seat belt pretensioners will deploy.

## Status after a collision

### WARNING

-  Seat belts subjected to strain, as a result of an accident, should be renewed and the anchorages checked by a properly trained technician.

## FASTENING THE SEAT BELTS

### WARNING

-  Insert the tongue into the buckle until you hear a distinct click. You have not fastened the seat belt properly if you do not hear a click.



E74124

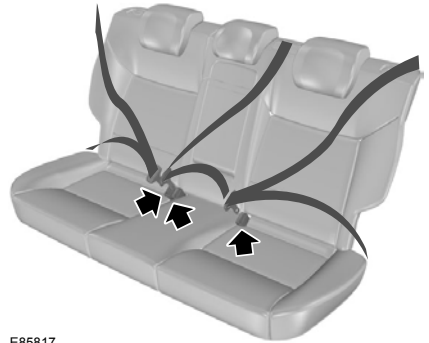

E85817

Pull the belt out steadily. It may lock if you pull it sharply or if the vehicle is on a slope.

Press the red button on the buckle to release the belt. Let it retract completely and smoothly.

# Occupant protection

## SEAT BELT HEIGHT ADJUSTMENT

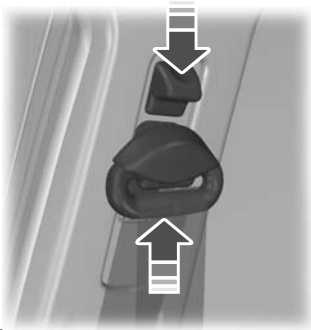

E104440

**Note:** *Lifting the slider slightly while pressing the locking button makes it easier to release the locking mechanism.*

To raise or lower, press the locking button on the adjuster and move as necessary.

## SEAT BELT REMINDER

### WARNING



The occupant protection system will only provide optimum protection when you use the seat belt properly.

**Note:** *The front passenger sport seat is not fitted with a seat belt reminder.*



The seat belt reminder warning lamp illuminates and an audible warning will sound if the driver's or front seat passenger's seat belt has not been fastened and the vehicle exceeds a relatively low speed. It will also illuminate if the driver's or front seat passenger's seat belt is unfastened when the vehicle is moving. The audible warning will go off after five minutes but the seat belt reminder warning lamp will remain on until the driver's or front seat passenger's seat belt is fastened.

## Deactivating the seat belt reminder

See your dealer.

## USING SEAT BELTS DURING PREGNANCY

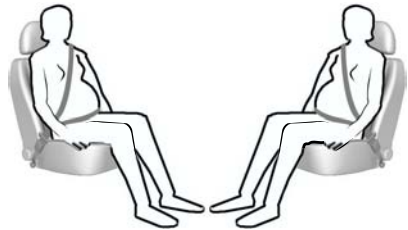

E68587

### WARNING



Position the seat belt correctly for your safety and that of your unborn child. Do not use only the lap strap or the shoulder strap.

Position the lap strap comfortably across your hips and low beneath your pregnant abdomen. Position the shoulder strap between your breasts, above and to the side of your pregnant abdomen.

# Occupant protection

## DISABLING THE PASSENGER AIRBAG

### WARNING

 Make sure that the passenger airbag is disabled when using a rearward facing child restraint on the front passenger seat.



E71313

## Fitting the passenger airbag deactivation switch

### WARNING

 If you need to fit a child restraint on a seat protected by an operational airbag in front of it, have a passenger airbag deactivation switch fitted. Ask your dealer for further information.

**Note:** *The key switch is located in the glove compartment with an airbag deactivation lamp in the instrument panel.*

If the airbag warning lamp illuminates or flashes when you are driving, this indicates a malfunction. See **Warning lamps and indicators** (page 59). Remove the child restraint and have the system checked immediately.

## Disabling the passenger airbag

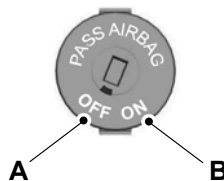

E71312

A Disabled

B Enabled

Turn the switch to position **A**.

When you switch the ignition on, check that the passenger airbag deactivation warning lamp illuminates.

## Enabling the passenger airbag

### WARNING

 Make sure that the passenger airbag is enabled when you are **not** using a child restraint on the front passenger seat.

Turn the switch to position **B**.

# Keys and remote controls

## GENERAL INFORMATION ON RADIO FREQUENCIES

### CAUTIONS

 The radio frequency used by your remote control can also be used by other short distance radio transmissions (e.g. amateur radios, medical equipment, wireless headphones, remote controls and alarm systems). If the frequencies are jammed, you will not be able to use your remote control. You can lock and unlock the doors with the key.

 Check your vehicle is locked before leaving it unattended. This will safeguard against any potential malicious frequency blocking.

**Note:** *You could unlock the doors if you press the buttons on the remote control unintentionally.*

The operating range between your remote control and your vehicle varies depending on the environment.

## PROGRAMMING THE REMOTE CONTROL

A maximum of eight remote controls (including any supplied with your vehicle) can be programmed. The remote controls must remain inside the vehicle during the programming procedure. Fasten the front seat belts and close all doors to ensure that conflicting chimes do not sound during programming.

### Programming a new remote control

1. To programme new remote controls turn the ignition key to position **II** four times within six seconds.

2. Turn the ignition to position **0**. A tone sounds to indicate that it is now possible to programme the remote controls for ten seconds.
3. Press any button on a new remote control. A tone will sound as confirmation.
4. Repeat this last step for all your remote controls, including your original. Do not remove the key from the ignition when pressing the button on this remote control.
5. Switch the ignition back on (position **II**) or wait for ten seconds without programming another remote control to end the key programming. Only the remote controls which you have just programmed are now able to lock and unlock the vehicle.

## Reprogramming the unlocking function

**Note:** *When you press the unlock button either all the doors are unlocked or only the driver's door and the luggage compartment lid are unlocked. Pressing the unlock button again unlocks all the doors.*

Press and hold the unlock and lock buttons on the remote key simultaneously for at least four seconds with the ignition off. The direction indicators will flash twice to confirm the change.

To return to the original unlocking function, repeat the process.

## CHANGING THE REMOTE CONTROL BATTERY



Make sure that you dispose of old batteries in an environmentally friendly way. Seek advice from your local authority regarding recycling.

## Keys and remote controls

### Remote control with a folding key blade

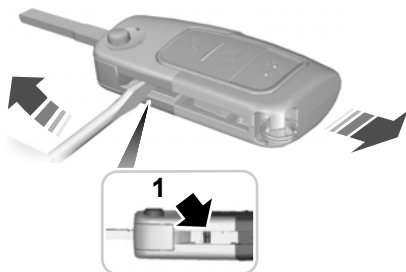

E74383

1. Insert a screwdriver as far as possible into the slot on the side of the remote control, push it towards the key blade and remove the key blade.

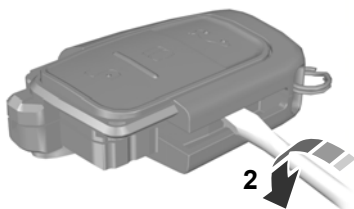

E74384

2. Twist the screwdriver in the position shown to start separating the two halves of the remote control.

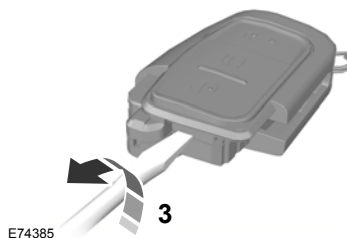

E74385

3. Twist the screwdriver in the position shown to separate the two halves of the remote control.

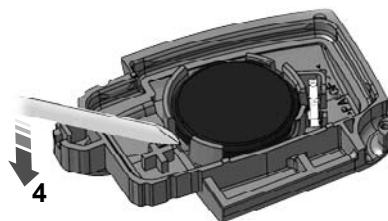

E126280

#### CAUTION

⚠ Do not touch the battery contacts or the printed circuit board with the screwdriver.

4. Carefully prise out the battery with the screwdriver.
5. Install a new battery (3V CR 2032) with the + facing downwards.
6. Assemble the two halves of the remote control.
7. Install the key blade.

# Keys and remote controls

## Remote control without a folding key blade

### Type 1

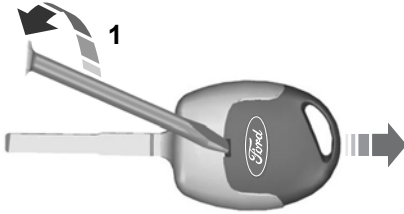

E126152

1. Insert a screwdriver into the recess on the back of the key and remove the key blade.

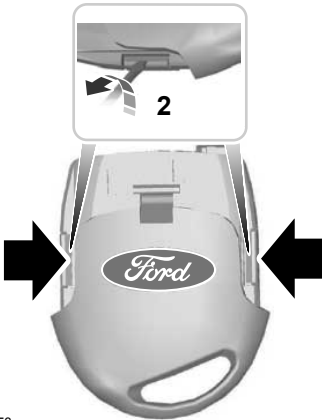

E126153

2. Release the retaining clips with the screwdriver and separate the two halves of the remote control.

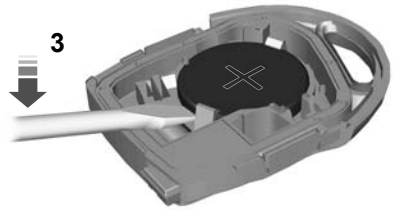

E126281

### CAUTION

! Do not touch the battery contacts or the printed circuit board with the screwdriver.

3. Carefully prise out the battery with the screwdriver.
4. Install a new battery (3V CR 2032) with the + facing upwards.
5. Assemble the two halves of the remote control.
6. Install the key blade.

### Type 2



E87964

1. Press and hold the pushbuttons on the edges to release the cover. Carefully remove the cover.

## Keys and remote controls

2. Remove the key blade.

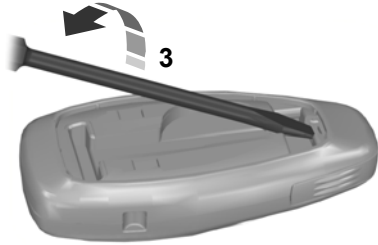

E105362

3. Twist a flat bladed screwdriver in the position shown to separate the two halves of the remote control.



E119190

4. Carefully insert the screwdriver in the position shown to open the remote control.

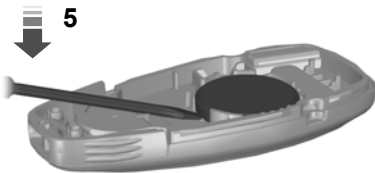

E125860

### CAUTION

! Do not touch the battery contacts or the printed circuit board with the screwdriver.

5. Carefully prise out the battery with the screwdriver.
6. Install a new battery (3V CR 2032) with the + facing downwards.
7. Assemble the two halves of the remote control.
8. Install the key blade.

# Locks

## LOCKING AND UNLOCKING

**Note:** Do not leave your keys in the vehicle.

### Locking

#### Locking with the key

Turn the top of the key towards the front of the vehicle.

#### Locking with the remote control

**Note:** The driver's door can be locked with the key. This needs to be used if the remote control is not functioning.



Press the button.

### Double locking

#### WARNING



Do not activate double locking when persons or animals are inside the vehicle. You will not be able to unlock the doors from the inside if you have double locked them.

Double locking is a theft protection feature that prevents someone from opening the doors from the inside. You can only double lock the doors if they are all closed.

#### Double locking with the key

Turn the key to the lock position twice within three seconds.

#### Double locking with the remote control



Press the button twice within three seconds.

### Unlocking

#### Unlocking with the key

Turn the top of the key towards the rear of the vehicle.

#### Unlocking with the remote control

**Note:** The driver's door can be unlocked with the key. This needs to be used if the remote control is not functioning.

**Note:** If the vehicle remains locked for several weeks, the remote control will be disabled. The vehicle must be unlocked and the engine started using the key. Unlocking and starting the vehicle once will enable the remote control.



Press the button.

### Automatic relocking

The doors will relock automatically if you do not open a door within 45 seconds of unlocking the doors with the remote control. The door locks and the alarm will return to their previous state.

### Reprogramming the unlocking function

The unlocking function may be reprogrammed so that only the driver's door is unlocked ( See **Programming the remote control** (page 30). ).

### Locking and unlocking confirmation

**Note:** If your vehicle has double locking, the direction indicators will only flash twice once you have activated double locking.

When you lock the doors, the direction indicators will flash twice.

When you unlock the doors, the direction indicators will flash once.

# Locks

## Locking and unlocking the doors from inside



Press the button. For item location. See **Quick start** (page 10).

## Luggage compartment lid Manual opening



E125429

To open the luggage compartment, press the switch. The driver's door must be unlocked.

## Opening with the remote control



Press the button twice within three seconds.

## Closing the luggage compartment lid



E89132

A recessed grip is incorporated inside the luggage compartment lid to facilitate closing.

## Locking the doors individually with the key

**Note:** If the central locking function fails to operate, the doors can be individually locked using the key in the position shown.

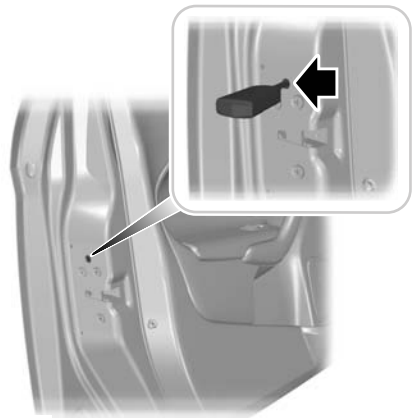

E112203

# Locks

## Left-hand side

Turn clockwise to lock.

## Right-hand side

Turn anti-clockwise to lock.

## Unlocking

**Note:** If the child safety locks have also been activated, pulling the internal lever will only deactivate the emergency locking and not the child safety lock. The doors can only be opened using the external door handle.

**Note:** If the doors have been unlocked using this method, the doors must be locked individually until the central locking function has been repaired.

Unlock the driver's door using the key. The other doors can be unlocked individually by pulling the interior door handles on those doors.

## KEYLESS ENTRY

### General information

#### WARNING



The keyless entry system may not function if the key is close to metal objects or electronic devices such as mobile phones.

The passive entry system will not function if:

- The vehicle battery is flat.
- The passive key frequencies are jammed.
- The passive key battery is flat.

**Note:** If the passive entry system does not function, you will need to use the key blade to lock and unlock your vehicle.

The keyless system allows the driver to operate the vehicle without the use of a key or remote control.

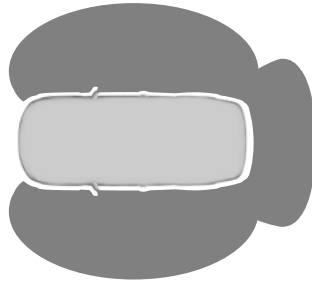

E78276

Passive locking and unlocking requires a valid passive key to be located within one of the three external detection ranges. These are located approximately one and a half metres from the driver and front passenger door handles and the luggage compartment lid.

## Passive key

The vehicle can be locked and unlocked with the passive key. The passive key can also be used as a remote control. See **Locking and unlocking** (page 34).

## Locking the vehicle

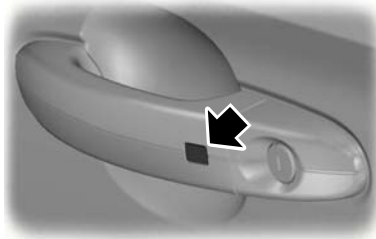

E87384

# Locks

## WARNING



The vehicle does not lock itself automatically. If no locking button is pressed, the vehicle will remain unlocked.

Locking buttons are located on each of the front doors.

To activate central locking and arm the alarm:

- Press a locking button once.

To activate double locking and arm the alarm:

- Press a locking button twice within three seconds.

**Note:** Once activated, the vehicle will remain locked for approximately three seconds. When the delay period is over, the doors can be opened again, provided the passive key is within the respective detection range.

Two short flashes of the direction indicators confirms that all the doors and the luggage compartment lid have been locked and that the alarm has been armed.

## Luggage compartment lid

**Note:** The luggage compartment lid cannot be closed and, will pop back up if the passive key is located inside the luggage compartment with the doors locked.

**Note:** If a second valid passive key is located within the luggage compartment lid detection range, the luggage compartment lid can be closed.

## Unlocking the vehicle

**Note:** If the vehicle remains locked for longer than three days, the keyless system will enter an energy-saving mode. This is to reduce the discharge of the vehicle battery. When the vehicle is unlocked while in this mode, the reaction time of the system may be a little longer than normal. Unlocking the vehicle once will deactivate the energy-saving mode.

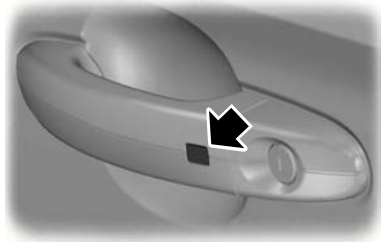

E87384

Press a locking button once.

**Note:** A valid passive key must be located within the detection range of that door.

One long flash of the direction indicators confirms that all the doors and the luggage compartment lid have been unlocked and that the alarm has been disarmed.

## Unlocking only the driver's door

If the unlocking function is reprogrammed so that only the driver's door and the luggage compartment lid are unlocked ( See **Programming the remote control** (page 30). ), note the following:

# Locks

If the driver's door is the first door which is opened, the other doors will remain locked. All the other doors can be unlocked from inside the vehicle by pressing the unlock button on the instrument panel. For item location: See **Quick start** (page 10). Doors can be unlocked individually by pulling the interior door handles on those doors.

If the front passenger door is the first door which is opened, **all** the doors and the luggage compartment lid will be unlocked.

## Disabled keys

Any keys left inside the vehicle interior when it is locked will be disabled.

A disabled key cannot be used to turn the ignition on or start the engine.

In order to use these passive keys again, they have to be enabled.

To enable all your passive keys, unlock the vehicle using a passive key or the remote control unlocking function.

All passive keys will then be enabled if the ignition is turned on or the vehicle is started using a valid key.

## Locking and unlocking the doors with the key blade



E87964

1. Carefully remove the cover.
2. Remove the key blade and insert it into the lock.

**Note:** Only the driver's door handle is fitted with a lock cylinder.

# Engine immobiliser

---

## PRINCIPLE OF OPERATION

The engine immobiliser is a theft protection system that prevents someone from starting the engine with an incorrectly coded key.

## CODED KEYS

**Note:** *Do not shield your keys with metal objects. This may prevent the receiver from recognising your key as a valid one.*

**Note:** *Have all of your remaining keys erased and recoded if you lose a key. Ask your dealer for further information. Have replacement keys recoded together with your existing keys.*

If you lose a key, you can obtain a replacement from your Ford Dealer. If possible, provide them with the key number from the tag provided with the original keys. You can also obtain additional keys from your Ford Dealer.

## ARMING THE ENGINE IMMOBILISER

The engine immobiliser is armed automatically a short time after you have switched the ignition off.

## DISARMING THE ENGINE IMMOBILISER

The engine immobiliser is disarmed automatically when you switch the ignition on with a correctly coded key.

The indicator in the instrument cluster will come on for approximately three seconds and then go out. If the indicator stays on for one minute or flashes for approximately one minute and then repeatedly at irregular intervals, your key has not been recognised. Remove the key and try again.

If you are unable to start the engine with a correctly coded key, this indicates a malfunction. Have the immobiliser checked immediately.

# Alarm

---

## PRINCIPLE OF OPERATION

The system acts as a deterrent against unauthorised access to your vehicle through the doors and the bonnet. It also protects the audio unit.

### Triggering the alarm

Once armed, the alarm is triggered in any of the following ways:

- If someone opens a door, the luggage compartment or the bonnet without a valid key or remote control.
- If someone removes the audio system.
- If the ignition is turned to position **I**, **II** or **III** without a valid key.

If the alarm is triggered, the alarm horn will sound for 30 seconds and the hazard warning flashers will flash for five minutes.

Any further attempts to perform one of the above will trigger the alarm again.

## ARMING THE ALARM

To arm the alarm, lock the vehicle. See **Locks** (page 34).

### Automatic arming delay

The 12 seconds arming delay begins when the bonnet, luggage compartment and all doors are closed.

## DISARMING THE ALARM

### Vehicles without keyless entry

Disarm and silence the alarm by unlocking the doors with the key and switching the ignition on with a correctly coded key, or unlocking the doors with the remote control.

### Vehicles with keyless entry

**Note:** *A valid passive key must be located within the detection range of that door for keyless entry. See **Keyless entry** (page 36).*

Disarm and silence the alarm by unlocking the doors and switching the ignition on, or unlocking the doors or the luggage compartment lid with the remote control.

# Steering wheel

## ADJUSTING THE STEERING WHEEL

### WARNING

 Never adjust the steering wheel when the vehicle is moving.

**Note:** Make sure that you are sitting in the correct position. See **Sitting in the correct position** (page 81).

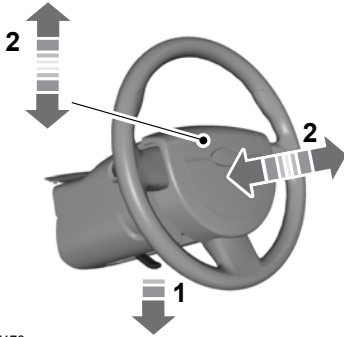

E95178



E95179

### WARNING

 Make sure that you fully engage the locking lever when returning it to its original position.

## AUDIO CONTROL

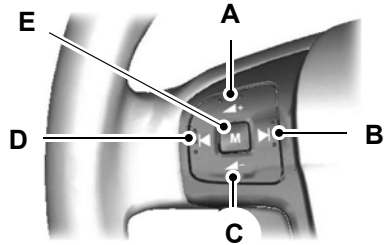

E72288

- A Volume up
- B Seek up
- C Volume down
- D Seek down
- E Mode

### Mode

Press and **hold** the mode button to select the audio source.

Press the mode button to:

- tune the radio to the next preset station
- accept an incoming telephone call
- end a telephone call.

### Seek

Press the seek button to:

- tune the radio to the next station up or down the frequency band
- play the next or the previous CD track.

# Steering wheel

---

Press and **hold** the seek button to:

- tune the radio up or down the frequency band
- seek through a CD track.

## VOICE CONTROL



E102756

Press the button to select or deselect voice control.

For further information See **Voice control** (page 182).

# Wipers and washers

## WINDSCREEN WIPERS



E102032

- A Single wipe
- B Intermittent wipe
- C Normal wipe
- D High speed wipe

## Intermittent wipe

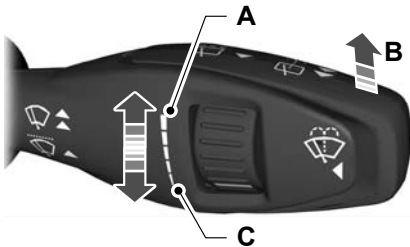

E102033

- A Short wipe interval
- B Intermittent wipe
- C Long wipe interval

The rotary control can be used to adjust the intermittent wipe interval.

## Automatic wiper system

Some models without autowipers are fitted with a speed-dependent front screen wiper system.

When the vehicle is slowed to walking speed or is brought to a standstill, the wiper speed will automatically switch to the next lower wiper speed setting.

When the vehicle speed is increased, the wiper speed will return to the manually-chosen setting.

Moving the wiper lever when the system is operating will switch off the system.

If the vehicle is again slowed to walking speed or is brought to a standstill, the system is reactivated.

## AUTOWIPERS

### CAUTIONS

- ⚠ Do not switch autowipers on in dry weather conditions. The rain sensor is very sensitive and the wipers may operate if dirt, mist or flies hit the windscreen.
- ⚠ Replace the wiper blades as soon as they begin to leave bands of water and smears. If you do not replace them, the rain sensor will continue to detect water on the windscreen and the wipers will operate, even though the majority of the windscreen is dry.
- ⚠ Fully defrost the windscreen in icy conditions before you switch autowipers on.
- ⚠ Switch autowipers off before you enter a car wash.

# Wipers and washers

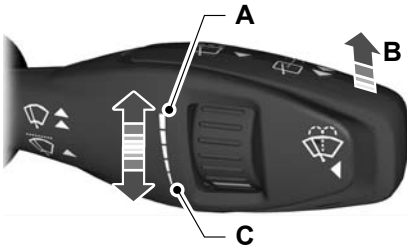

E102033

- A High sensitivity
- B On
- C Low sensitivity

If you switch autowipers on, the wipers will not cycle until water is detected on the windscreen. The rain sensor will then continuously measure the amount of water on the windscreen and adjust the speed of the wipers automatically.

Adjust the sensitivity of the rain sensor using the rotary control. With low sensitivity, the wipers will operate when the sensor detects a lot of water on the windscreen. With high sensitivity, the wipers will operate if the sensor detects a small amount of water on the windscreen.

## WINDSCREEN WASHERS



E102051

## WARNING



Do not operate the washer for more than 10 seconds at a time, and never when the reservoir is empty.

While the button at the end of the lever is pressed the washer will work in conjunction with the wipers.

After releasing the button, the wipers operate for a short time.

## REAR WINDOW WIPER AND WASHERS

### Intermittent wipe



E102052

Pull the lever towards the steering wheel.

### Reverse gear wipe

The rear wiper will be activated automatically when selecting reverse gear if:

- the rear wiper is not already switched on,
- the wiper lever is in position **A**, **B**, **C** or **D** and
- the front wiper is operating (when set to position **B**).

The rear wiper will follow the front wiper interval (at intermittent or normal speed).

# Wipers and washers

## Rear window washer

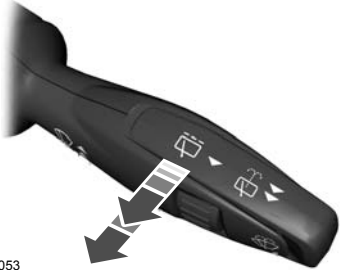

E102053

### WARNING



Do not operate the washer for more than 10 seconds at a time, and never when the reservoir is empty.

While the lever is pulled towards the steering wheel the washer will work in conjunction with the wipers.

Once the wash and wipe cycle is completed, the wipers will pause and then perform one more wipe to clear the windscreen.

After releasing the lever, the wipers operate for a short time.

## ADJUSTING THE WINDSCREEN WASHER JETS

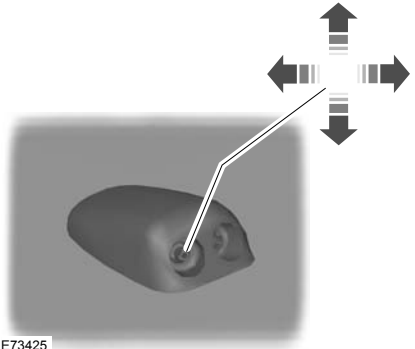

E73425

The eye ball jets can be adjusted precisely using a pin.

## CHECKING THE WIPER BLADES

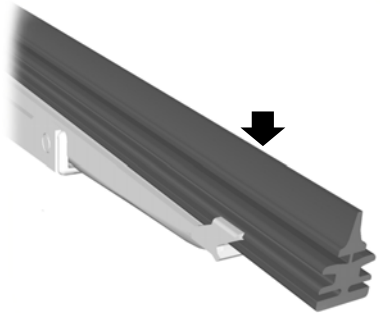

E66644

Run the tip of your fingers over the edge of the blade to check for roughness.

Clean the wiper blade lips with water applied with a soft sponge.

# Wipers and washers

## CHANGING THE WIPER BLADES

### Windscreen wiper blades

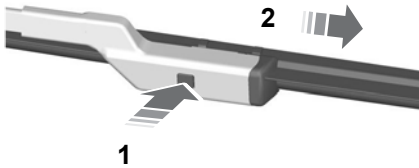

E72899

1. Press the locking button.
2. Remove the wiper blade.

**Note:** Make sure that the wiper blade locks into place.

3. Install in the reverse order.

### Rear window wiper blade

1. Lift the wiper arm.

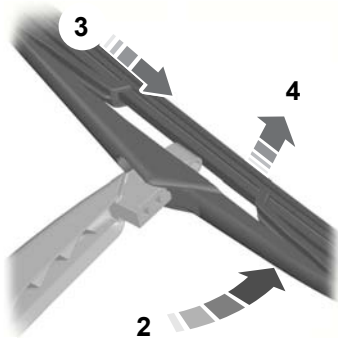

E86456

2. Position the wiper blade at right angles to the wiper arm.
3. Disengage the wiper blade from the wiper arm.
4. Remove the wiper blade.

**Note:** Make sure that the wiper blade locks into place.

5. Install in the reverse order.

# Lighting

## LIGHTING CONTROL

### Lighting control positions

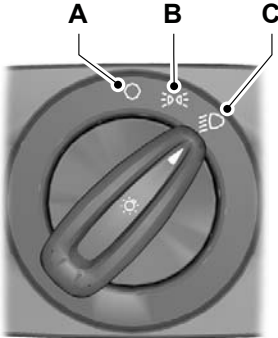

E70718

- A Off
- B Side and tail lamps
- C Headlamps

### Parking lamps

#### CAUTION

 Prolonged use of the parking lamps will discharge the battery.

Switch off the ignition.

Set the lighting control to position **B**.

### Main and dipped beam



E101829

Pull the lever fully towards the steering wheel to switch between main and dipped beam.

### Headlamp flasher

Pull the lever slightly towards the steering wheel.

### Home safe lighting

Switch the ignition off and pull the direction indicator lever towards the steering wheel to switch the headlamps on. You will hear a short tone. The headlamps will go off automatically after three minutes with any door open, or 30 seconds after the last door has been closed.

With all doors closed, but within the 30 second delay, opening any door will result in the three minute timer starting again.

The home safe lights can be cancelled by either pulling the direction indicator lever towards the steering wheel again or by turning the ignition switch on.

# Lighting

## AUTOLAMPS



E70719

**Note:** If you have switched autolamps on, you can only switch the main beam on when autolamps has switched the headlamps on.

The headlamps will come on and go off automatically depending on the ambient light.

## FRONT FOG LAMPS



E70721

### WARNING



Only use the front fog lamps when visibility is considerably restricted by fog, snow or rain.

## REAR FOG LAMPS



E70720

### WARNINGS



Only use the rear fog lamps when visibility is restricted to less than 50 metres.



Do not use the rear fog lamps when it is raining or snowing and visibility is more than 50 metres.

## HEADLAMP LEVELLING

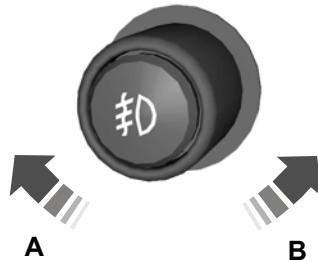

E70722

- A Raised headlamp beams
- B Lowered headlamp beams

You can adjust the level of the headlamp beams according to the vehicle load.

# Lighting

## Recommended headlamp levelling control positions

Load		Load in luggage compartment <sup>1</sup>	Control position
Front seats	Rear seats		
1-2	-	-	0
1-2	3	-	2
1-2	3	Max	2,5
1-2 <sup>2</sup>	-	Max	3,5 <sup>2</sup>
1	-	Max	4

<sup>1</sup> See **Vehicle identification plate** (page 154).

<sup>2</sup> Van only.

## HAZARD WARNING FLASHERS



For item location: See **Quick start** (page 10).

## DIRECTION INDICATORS



E102016

**Note:** Tap the lever up or down to make the direction indicators flash only three times.

## INTERIOR LAMPS

### Courtesy lamp

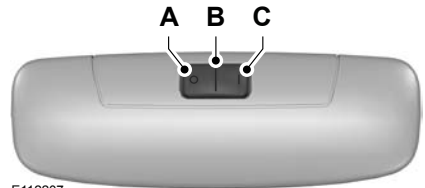

E112207

- A Off
- B Door contact
- C On

If you set the switch to position **B**, the courtesy lamp will come on when you unlock or open a door or the luggage compartment lid. If you leave a door open with the ignition switch off, the courtesy lamp will go off automatically after some time to prevent the vehicle battery from discharging. To switch it back on, switch on the ignition for a short time.

# Lighting

The courtesy lamp will also come on when you switch off the ignition. It will go off automatically after a short time or when you start or restart the engine.

If you set the switch to position **C** with the ignition switch off, the courtesy lamp will come on. It will go off automatically after a short time to prevent the vehicle battery from discharging. To switch it back on, switch on the ignition for a short time.

## Reading lamps



E112208

If you switch off the ignition, the reading lamps will go off automatically after some time to prevent the vehicle battery from discharging. To switch them back on, switch on the ignition for a short time.

## REMOVING A HEADLAMP

1. Open the bonnet. See **Opening and closing the bonnet** (page 128).

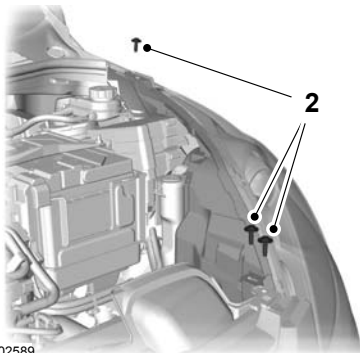

E102589

2. Remove the screws.

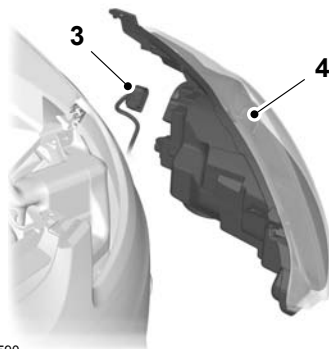

E102590

3. Disconnect the electrical connector.
4. Remove the headlamp.

**Note:** When fitting the headlamp, make sure that you fully engage the headlamp in the retaining clips.

## CHANGING A BULB

### WARNINGS



Switch the lights and the ignition off.



Let the bulb cool down before removing it.

### CAUTIONS



Do not touch the glass of the bulb.



Only fit bulbs of the correct specification. See **Bulb specification chart** (page 55).

## Headlamp

### Direction indicator

1. Remove the headlamp. See **Removing a headlamp** (page 50).

# Lighting

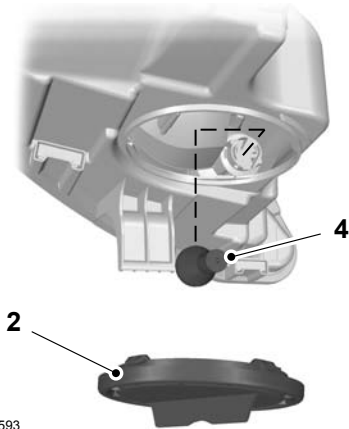

E102593

2. Remove the cover.
3. Turn the bulb holder anti-clockwise and remove it.
4. Gently press the bulb into the bulb holder, turn it anti-clockwise and remove it.

## Headlamp dipped beam

1. Remove the headlamp. See **Removing a headlamp** (page 50).

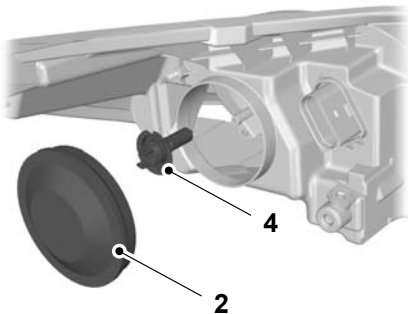

E102598

2. Remove the cover.

3. Turn the bulb holder anti-clockwise and remove it.
4. Remove the bulb.

## Headlamp main beam

1. Remove the headlamp. See **Removing a headlamp** (page 50).

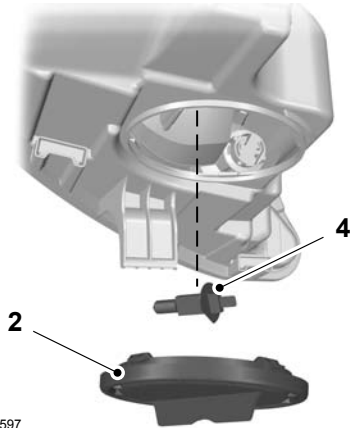

E102597

2. Remove the cover.
3. Release the retaining clip. Turn the bulb holder anti-clockwise and remove it.
4. Remove the bulb.

## Side lamp

1. Remove the headlamp. See **Removing a headlamp** (page 50).

# Lighting

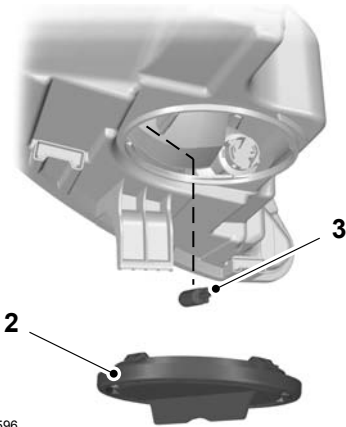

E102596

2. Remove the cover.
3. Pull the bulb holder and remove it. Remove the bulb.

## Side repeaters

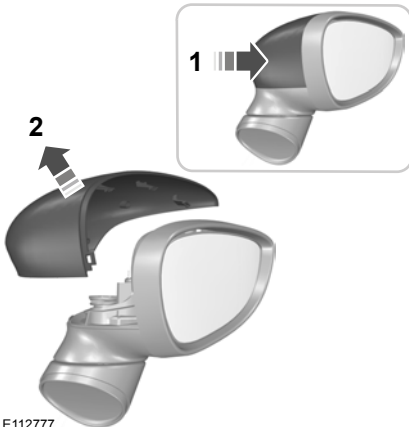

E112777

1. Press the side of the cover to release the clips.
2. Remove the cover.

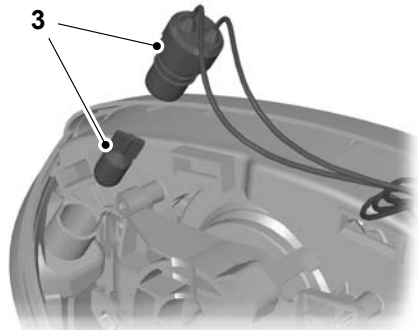

E112778

3. Remove the bulb and bulb holder. Remove the bulb.

## Front fog lamps

**Note:** *The front fog lamps are not serviceable items, please consult your dealer if these fail.*

## Rear lamps

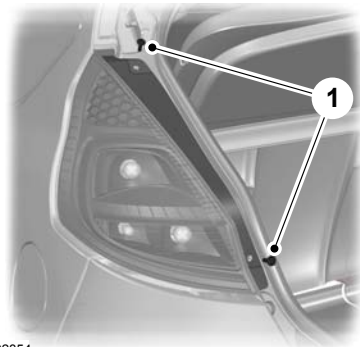

E102854

1. Remove the screws.

# Lighting



E112775

2. Lift up the luggage compartment seal.



E112776

3. Remove the carpet.

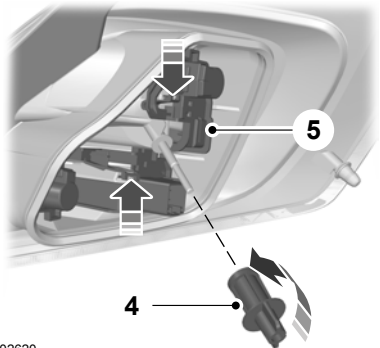

E102620

4. Remove the wing nut.

5. Remove the rear lamp and unclip the bulb holder.

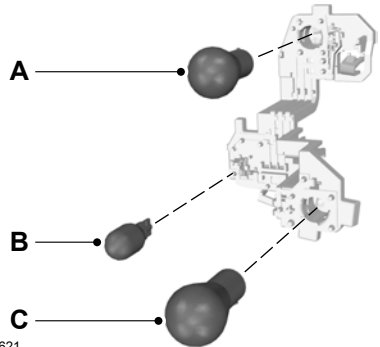

E102621

A Tail and Brake

B Reverse

C Indicator

4. Remove the bulb.

## Rear fog lamps

**Note:** *The rear fog lamps are not serviceable items, please consult your dealer if these fail.*

# Lighting

## Central high mounted brake lamp

**Note:** The LED board is not a serviceable item, please consult your dealer if this fails.

## Number plate lamp

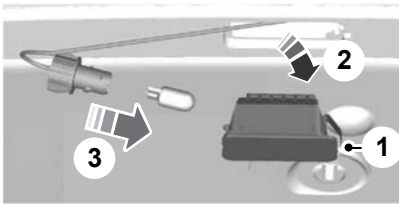

E72789

1. Carefully release the spring clip.
2. Remove the lamp.
3. Remove the bulb.

## Interior lamp

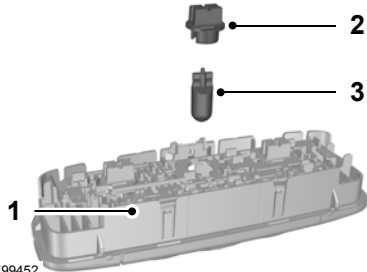

E99452

1. Carefully prise out the lamp.
2. Turn the bulb holder anti-clockwise and remove it.

3. Remove the bulb.

## Reading lamps

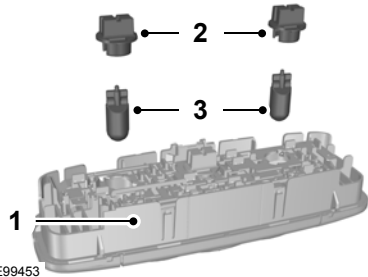

E99453

1. Carefully prise out the lamp.
2. Turn the bulb holder anti-clockwise and remove it.
3. Remove the bulb.

## Luggage compartment lamp

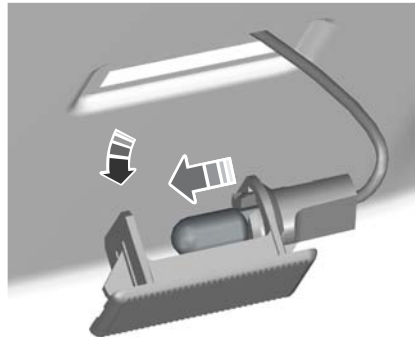

E72784

1. Carefully prise out the lamp.
2. Remove the bulb.

# Lighting

---

## BULB SPECIFICATION CHART

Lamp	Specification	Power (watt)
Front direction indicator	PY21W	21
Headlamp main beam	H1	55
Headlamp dipped beam	H7	55
Side repeater	WY5W	5
Front fog lamp	H11	55
Side lamp	W5W	5
Rear direction indicator	PY21W	21
Brake and tail lamp	P21/5W	21/5
Rear fog lamp	P21W	21
Reversing lamp	W16W	16
Number plate lamp	W5W	5
Interior lamp	W6W	6
Reading lamp	W5W	5
Luggage compartment lamp	W5W	5

# Windows and mirrors

## ELECTRIC WINDOWS

### WARNING



Do not operate the electric windows unless they are free from obstruction.

**Note:** If you operate the switches often during a short period of time, the system might become inoperable for a certain time to prevent damage due to overheating.

Switch on the ignition to operate the electric windows.

### Driver's door switches

You can operate all the windows with the switches on the door trim panel of the driver's door.



E121510

### Opening and closing the driver's window automatically

Press or lift the switch to the second action point and release it completely. Press or lift it again to stop the window.

## Safety switch for rear windows

**Note:** You can always operate the rear windows from the driver's door.



E121511

A switch in the driver's door disables the rear electric window switches.

The light in the switch comes on and the lights in the rear window switches go off when the rear windows are disabled.

## Anti-trap function

### WARNING



Careless closing of the window can override the protection function and cause injuries.

**Note:** The anti-trap function is only available on the driver's window.

The electric window will stop automatically while closing and reverse some distance if there is an obstacle in the way.

# Windows and mirrors

## Overriding the anti-trap function

### CAUTION

 While you close the window for the third time, the anti-trap function is disabled. Make sure there are no obstacles in the way of the closing window.

To override this protection function when there is a resistance, e.g. in the winter, proceed as follows:

1. Close the window twice until it reaches the resistance and let it reverse.
2. Close the window a third time to the resistance. The anti-trap function is disabled and you cannot close the window automatically. The window will override the resistance and you can close it fully.
3. If the window does not close after the third attempt, have it checked by a properly trained technician.

## Resetting the memory of the electric window

### WARNING

 The anti-trap function is deactivated until you have reset the memory.

After the battery has been disconnected from the vehicle you must reset the memory for the driver's window:

1. Lift the switch until the window is fully closed. Hold the switch lifted for one more second.
2. Release the switch and lift it again, two or three times, for one more second.
3. Open the window and try to close it automatically.
4. Reset and repeat procedure if the window does not close automatically.

## EXTERIOR MIRRORS

### WARNING

 Do not overestimate the distance of the objects that you see in the convex mirror. Objects seen in convex mirrors will appear smaller and further away than they actually are.

## Manual folding mirrors

### Folding

Push the mirror towards the door window glass.

### Unfolding

Make sure that you fully engage the mirror in its support when returning it to its original position.

## ELECTRIC EXTERIOR MIRRORS

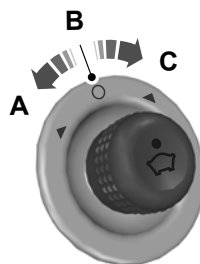

E71280

- A Left-hand mirror
- B Off
- C Right-hand mirror

# Windows and mirrors

## Mirror tilting positions

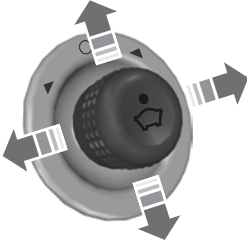

E71281

## Electric folding mirrors

### Automatic folding and unfolding

**Note:** *If the mirrors have been folded using the manual fold button they can only be unfolded using the manual fold button.*

The mirrors will fold automatically when you lock the vehicle with the key, the remote control or a keyless entry system request. The mirrors will unfold when you unlock the vehicle with the key, the remote control, a keyless entry system request, the driver's interior door handle or starting the engine.

### Manual folding and unfolding

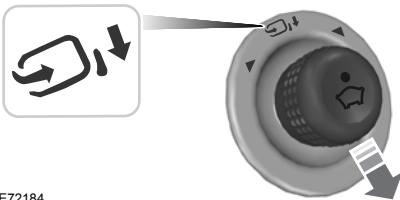

E72184

## AUTO-DIMMING MIRROR

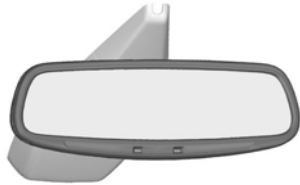

E71028

The auto-dimming mirror will adjust automatically when hit by glaring light from behind. It will not work when you have selected reverse gear.

# Instruments

## GAUGES

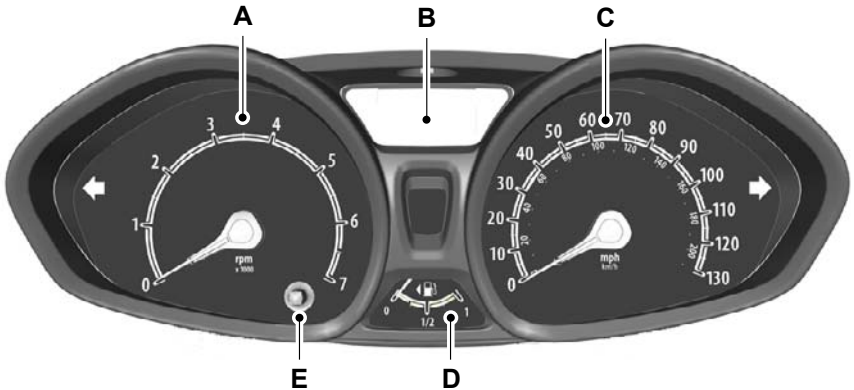

E102660

- A Tachometer
- B Information display
- C Speedometer
- D Fuel gauge
- E Tripmeter reset button

## Fuel gauge

The arrow adjacent to the fuel pump symbol indicates on which side of the vehicle the fuel filler cap is located.

## WARNING LAMPS AND INDICATORS

The following warning lamps and indicators illuminate when the ignition is switched on:

- ABS
- Airbag
- Brake system
- Coolant temperature

- Doors open
- Engine
- Frost
- Ignition
- Oil pressure
- Power steering
- Stability control (ESP)

If a warning or indicator lamp does not illuminate when the ignition is switched on, it indicates a malfunction. Have the system checked by a properly trained technician.

# Instruments

## ABS warning lamp



If it illuminates when you are driving, this indicates a malfunction. You will continue to have normal braking (without ABS). Have the system checked by a properly trained technician as soon as possible.

## Airbag warning lamp



If it illuminates when driving, this indicates a malfunction. Have the system checked by a properly trained technician.

## Brake system lamp



It illuminates when the parking brake is engaged.

### WARNING



Reduce your speed gradually and stop your vehicle as soon as it is safe to do so. Use your brakes with care.

If it illuminates when you are driving, check that the parking brake is not engaged. If the parking brake is not engaged, this indicates a malfunction. Have the system checked by a properly trained technician immediately.

## Coolant temperature warning lamp

### CAUTION



Do not resume your journey if it illuminates despite the level being correct. Have the system checked by a properly trained technician immediately.



If it stays on after starting or illuminates when driving, this indicates a malfunction. Stop your vehicle as soon as it is safe to do so and switch the engine off. Check the coolant level. See **Engine coolant check** (page 133).

## Cruise control indicator



It will illuminate when you have set a speed using the cruise control system. See **Using cruise control** (page 106).

## Direction indicator



Flashes during operation. A sudden increase in the rate of flashing warns of a failed indicator bulb. See **Changing a bulb** (page 50).

## Doors open warning lamp



Illuminates when the ignition is switched on and remains on if any door, the bonnet or the luggage compartment is not closed properly.

# Instruments

## Engine warning lamps

### Malfunction indicator lamp



### Powertrain warning lamp



#### All vehicles

If either lamp illuminates when the engine is running, this indicates a fault. The engine will continue to run but it may have limited power. If it flashes when you are driving, **reduce the speed of your vehicle immediately**. If it continues to flash, avoid heavy acceleration or deceleration. Have the system checked by a properly trained technician immediately.

#### WARNING



Have this checked immediately.

If **both** lamps illuminate together, **stop your vehicle as soon as it is safe to do so** (continued use may cause reduced power and cause the engine to stop). Turn the ignition off and attempt to restart the engine. If the engine restarts have the system checked by a properly trained technician immediately. If the engine does not restart the vehicle must be checked before continuing your journey.

### Front fog lamp indicator



It will illuminate when you switch the front fog lamps on.

## Frost warning lamp

#### WARNING



Even if the temperature rises to above +4°C there is no guarantee that the road is free of hazards caused by inclement weather.



It will illuminate and glow orange when the outside air temperature is between 4°C and 0°C. It will glow red when the temperature is below 0°C.

## Fuel in oil warning lamp



It will illuminate when the engine oil has been diluted with fuel. Have the engine oil changed as soon as possible.

## Oil pressure warning lamp

#### CAUTION



Do not resume your journey if it illuminates despite the level being correct. Have the system checked by a properly trained technician immediately.



If it stays on after starting or illuminates when driving, this indicates a malfunction. Stop your vehicle as soon as it is safe to do so and switch the engine off. Check the engine oil level. See **Engine oil check** (page 133).

## Glow plug indicator



If it illuminates, wait until it extinguishes before starting.

# Instruments

## Headlamp indicator



It will illuminate when you switch the headlamp dipped beam or the side and tail lamps on.

## Ignition warning lamp



If it illuminates when driving, this indicates a malfunction. Switch off all unnecessary electrical equipment. Have the system checked by a properly trained technician immediately.

## Low fuel level warning lamp



If it illuminates, refuel as soon as possible.

## Main beam indicator



It will illuminate when you switch the headlamp main beam on. It will flash when you use the headlamp flasher.

## Message indicator



It will illuminate when a new message is stored in the information display. See

**Information messages** (page 70).

## Power steering warning lamp



Illuminates to indicate a malfunction of the power steering system. Full steering will be maintained but you will need to exert greater force on the steering wheel. Have the system checked by a properly trained technician as soon as possible.

## Rear fog lamp indicator



It will illuminate when you switch the rear fog lamps on.

## Seat belt reminder



See **Seat belt reminder** (page 28).

## Shift indicator



It will illuminate to inform you that shifting to a higher gear may give better fuel economy and lower CO2 emissions. It will not illuminate during periods of high acceleration, braking or when the clutch pedal is pressed.

## Stability control (ESP) indicator



While driving, it flashes during activation of the system. After switching on the ignition, if it does not illuminate or illuminates continuously while driving, this indicates a malfunction. During a malfunction, the system switches off. Have the system checked by a properly trained technician as soon as possible.

If you switch ESP off, the warning lamp will illuminate. The lamp will go out when you switch the system back on or when you switch the ignition off.

## AUDIBLE WARNINGS AND INDICATORS

### Automatic transmission

If position **P** is not selected, a warning chime will sound when the driver's door is opened.

# Instruments

---

## Key outside car

### Vehicles with the keyless system

If the engine is running and a passive key is no longer detected within the vehicle interior, a warning chime will sound as soon as the door is closed.

### Lights on

A warning chime will sound if the driver's door is opened with the exterior lights switched on and the ignition switched off.

### Low fuel

A warning chime will sound when the low fuel warning lamp illuminates.

## Seat belt reminder

### WARNINGS



The seat belt reminder remains in stand-by mode when the front seat belts have been fastened. It will be reactivated if either seat belt is unfastened.



Do not sit on top of a fastened seat belt to prevent the seat belt reminder from coming on. The occupant protection system will only provide optimum protection when you use the seat belt properly.

---

When the vehicle's speed exceeds the pre-determined limit, a warning chime will sound if either of the front seat belts are unfastened. The chime will stop after five minutes.

# Information displays

## GENERAL INFORMATION

**Note:** The information display will remain on for several minutes after you switch off the ignition.

Various systems can be programmed using the audio unit controls.

## Device list

The icon changes to show the current function in use.



CD



Radio



Auxiliary input



Phone



Settings

## Menu structure

### Type 1

CD

— Folder / Tracks

RADIO

— FM  
— FM AST  
— AM  
— AM AST

- Stations

- Stations

- Stations

- Stations

AUX

LINE IN

## Controls



E103626

Press the **up** and **down** arrow buttons to scroll through and highlight the options within a menu.

Press the **right** arrow button to enter a sub-menu.

Press the **left** arrow button to exit a menu.

Hold the **left** arrow button pressed at any time to return to the main menu display (escape button).

Press the **OK** button to choose and confirm a setting.

E104381

# Information displays

---

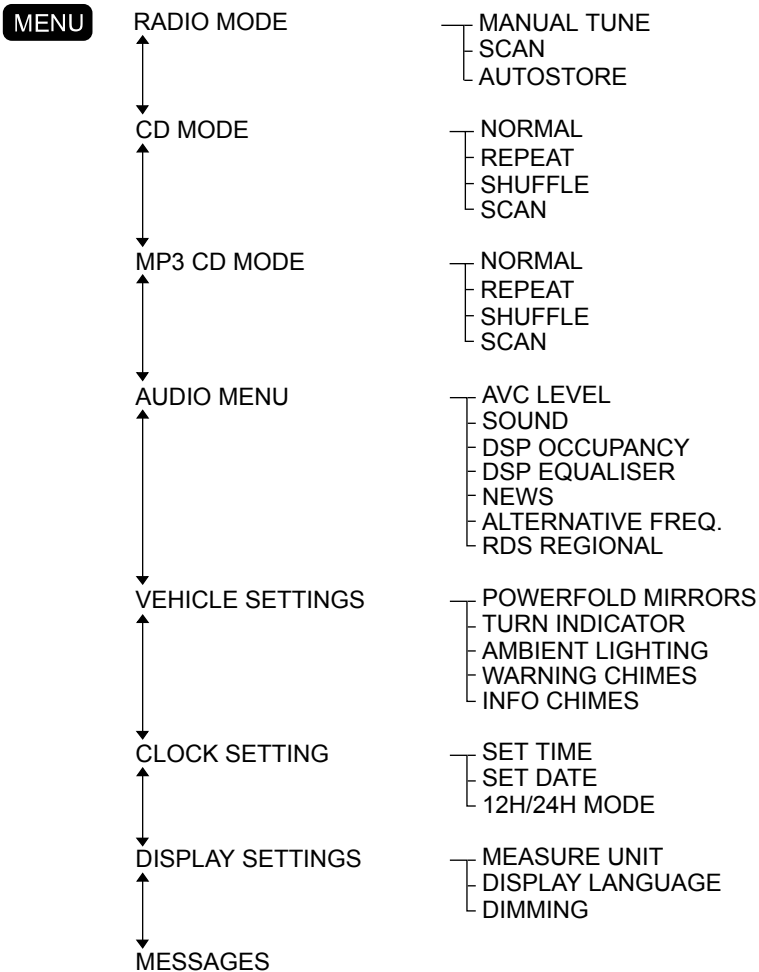

E104129

# Information displays

---

## **Type 2**

**Note:** *Phone menu depends on phone capabilities and call status etc.*

Use the **MENU** button and left arrow key to access the menus.

# Information displays

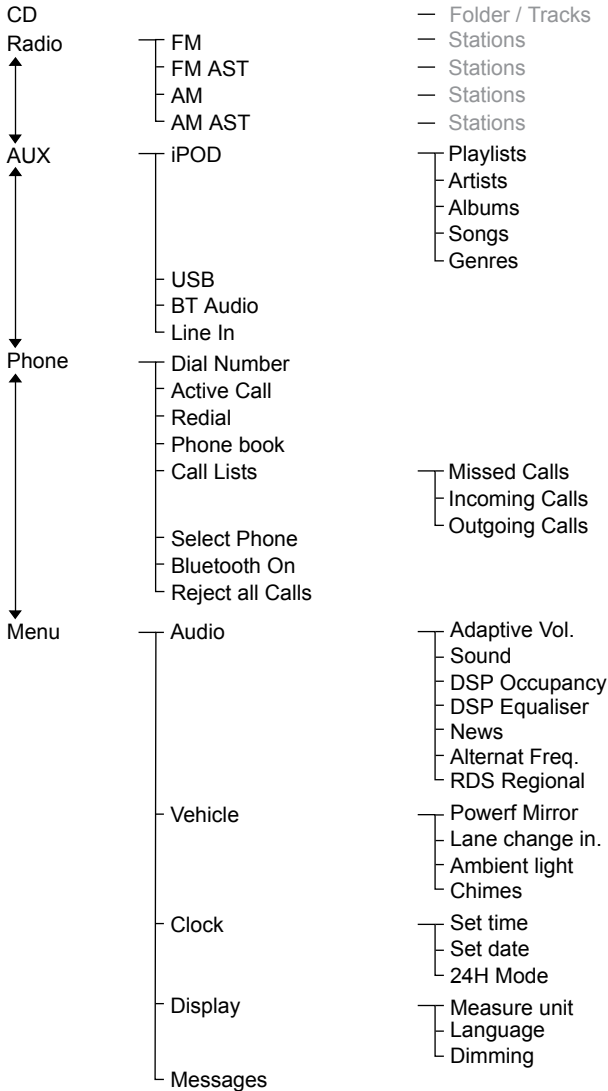

E104130

# Information displays

## Type 3

**Note:** Phone menu depends on phone capabilities and call status etc.

Use the **MENU** button and left arrow key to access the menus.

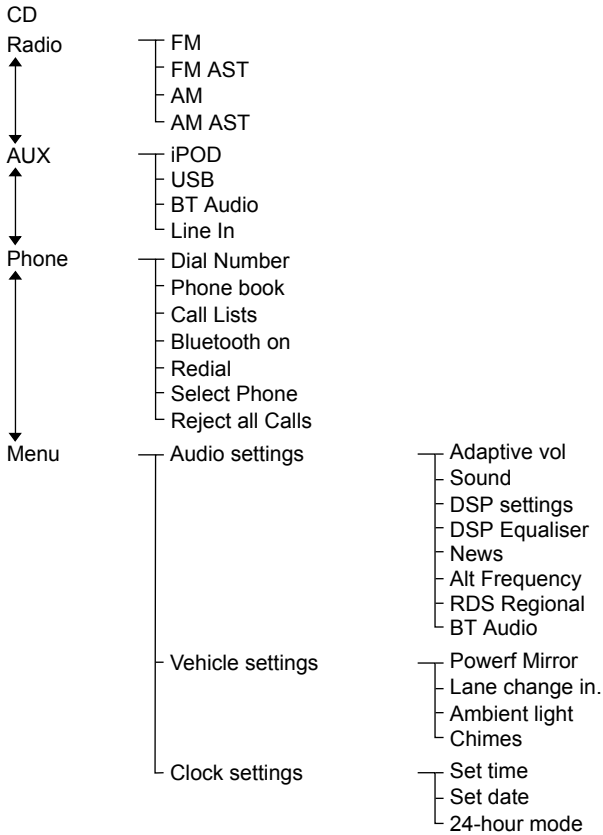

E129773

# Information displays

## TRIP COMPUTER

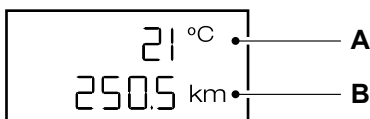

E103499

- A Outside air temperature
- B Trip computer

## Trip computer



E102759

Press the button to scroll through the displays.

To reset the trip, average fuel consumption and average speed, scroll to the required display and press and hold the button.

The trip computer includes the following information displays:

### Trip

Registers the mileage of individual journeys.

### Distance to empty

Indicates the approximate distance the vehicle will travel on the fuel remaining in the tank. Changes in driving pattern may cause the value to vary.

### Average fuel consumption

Indicates the average fuel consumption since the function was last reset.

### Average speed

Indicates the average speed calculated since the function was last reset.

### Odometer

Registers the total mileage of the vehicle.

## PERSONALISED SETTINGS

### Measure units

To toggle between metric and imperial units, scroll to this display and press the **OK** button.

toggling the measure units using this display will affect the following displays:

- Distance to empty
- Average fuel consumption
- Instantaneous fuel consumption
- Average speed

### Chime deactivation

The following chimes can be deactivated:

- Warning messages.
- Information messages.

# Information displays

## INFORMATION MESSAGES

### Airbag

Message	Warning lamp	Action
Airbag malfunction service now	amber	Have the system checked by a properly trained technician as soon as possible.

### Alarm

Message	Warning lamp	Action
Alarm triggered check vehicle	amber	See <b>Alarm</b> (page 40).
Interior scan deactivated	amber	See <b>Alarm</b> (page 40).
Alarm system malfunction next service	-	Have the system checked by a properly trained technician.

### Doors open

Message	Warning lamp	Action
Driver door open	red	Vehicle is moving. Stop the vehicle as soon as safely possible and close.
Driver's rear door open	red	Vehicle is moving. Stop the vehicle as soon as safely possible and close.
Passenger door open	red	Vehicle is moving. Stop the vehicle as soon as safely possible and close.
Passenger rear door open	red	Vehicle is moving. Stop the vehicle as soon as safely possible and close.
Boot open	red	Vehicle is moving. Stop the vehicle as soon as safely possible and close.
Bonnet open	red	Vehicle is moving. Stop the vehicle as soon as safely possible and close. See <b>Opening and closing the bonnet</b> (page 128).

## Information displays

Message	Warning lamp	Action
Driver door open	amber	Vehicle not moving. Close.
Driver's rear door open	amber	Vehicle not moving. Close.
Passenger door open	amber	Vehicle not moving. Close.
Passenger rear door open	amber	Vehicle not moving. Close.
Boot open	amber	Vehicle not moving. Close.
Bonnet open	amber	Vehicle not moving. Close. See <b>Opening and closing the bonnet</b> (page 128).

### Engine

Message	Warning lamp	Action
Engine preheating	amber	See <b>Starting a diesel engine</b> (page 91).

### Engine immobiliser

Message	Warning lamp	Action
Immobiliser malfunction service now	red	Have the system checked by a properly trained technician as soon as possible.

### Keyless system

Message	Warning lamp	Action
Key not detected	amber	See <b>Keyless entry</b> (page 36).
Key outside car	amber	See <b>Keyless entry</b> (page 36).
Key battery low replace battery	amber	See <b>Changing the remote control battery</b> (page 30).
Turn ignition off use POWER button	amber	See <b>Keyless starting</b> (page 88).
To start press brake	-	See <b>Keyless starting</b> (page 88).

## Information displays

Message	Warning lamp	Action
To start press clutch	-	See <b>Keyless starting</b> (page 88).
Close boot or use spare key	-	See <b>Keyless entry</b> (page 36).
Steering lock engaged turn steering wheel	-	See <b>Steering wheel lock</b> (page 90).

### Lighting

Message	Warning lamp	Action
Left indicator malfunction change bulb	-	See <b>Changing a bulb</b> (page 50).
Right indicator malfunction change bulb	-	See <b>Changing a bulb</b> (page 50).

### Maintenance

Message	Warning lamp	Action
Brake fluid level low stop safely	red	See <b>Brake and clutch fluid check</b> (page 134).
Brake system malfunction stop safely	red	Have the system checked by a properly trained technician immediately.
Engine oil pressure low stop safely	red	See <b>Engine oil check</b> (page 133).
Engine malfunction service now	amber	Have the system checked by a properly trained technician as soon as possible.
Auto wiper/lights malfunction next service	amber	Have the system checked by a properly trained technician.
Engine oil change due next service	-	Have the system checked by a properly trained technician.

## Information displays

### Steering

Message	Warning lamp	Action
Steering malfunction service now	red	Have the system checked by a properly trained technician immediately.
Steering malfunction stop safely	red	Have the system checked by a properly trained technician immediately.
Power steering malfunction service now	amber	Full steering will be maintained but you will need to exert greater force on the steering wheel. Have the system checked by a properly trained technician as soon as possible.

### Transmission

Message	Warning lamp	Action
Transmission malfunction service now	red	Have the system checked by a properly trained technician immediately.
Transmission overtemp. stop safely	red	Under certain driving conditions it is possible that the clutches in the transmission can overheat. In these circumstances it is necessary to press the brake pedal and stop the vehicle to prevent damage to the transmission. Select <b>N (NEUTRAL)</b> or <b>P (PARK)</b> and apply the parking brake until the transmission has cooled and the message disappears from the display.
Vehicle not in PARK select P	-	See <b>Automatic transmission</b> (page 97). See <b>Starting the engine</b> (page 88).
To start select N or P	-	See <b>Automatic transmission</b> (page 97). See <b>Starting the engine</b> (page 88).

## Information displays

Message	Warning lamp	Action
To start press brake	-	See <b>Starting the engine</b> (page 88).
To start select N	-	See <b>Automatic transmission</b> (page 97). See <b>Starting the engine</b> (page 88).
Door open apply brake	-	See <b>Automatic transmission</b> (page 97). See <b>Starting the engine</b> (page 88).

### Stability control (ESP)

Message	Warning lamp	Action
ABS malfunction service now	amber	Have the system checked by a properly trained technician as soon as possible.
ESP malfunction next service	-	Have the system checked by a properly trained technician.
ESP off	-	See <b>Using stability control</b> (page 101).

# Climate control

## PRINCIPLE OF OPERATION

### Outside air

Keep the air intakes forward of the windscreen free from obstruction (snow, leaves etc.) to allow the climate control system to function effectively.

### Recirculated air

#### CAUTION

⚠ Prolonged use of recirculated air may cause the windows to mist up. If the windows mist up, follow the settings for defrosting and demisting the windscreen.

The air currently in the passenger compartment will be recirculated. Outside air will not enter the vehicle.

### Heating

Heating performance depends on the temperature of the engine coolant.

### Air conditioning

**Note:** The air conditioning operates only when the temperature is above 4°C (39°F).

**Note:** If you use the air conditioning, the fuel consumption of your vehicle will be higher.

Air is directed through the evaporator where it is cooled. Humidity is extracted from the air to help keep the windows free of mist. The resulting condensation is directed to the outside of the vehicle and it is therefore normal if you see a small pool of water under your vehicle.

### General information on controlling the interior climate

Fully close all the windows.

### Warming the interior

Direct the air towards your feet. In cold or humid weather conditions, direct some of the air towards the windscreen and the door windows.

### Cooling the interior

Direct the air towards your face.

## AIR VENTS

### Centre air vent

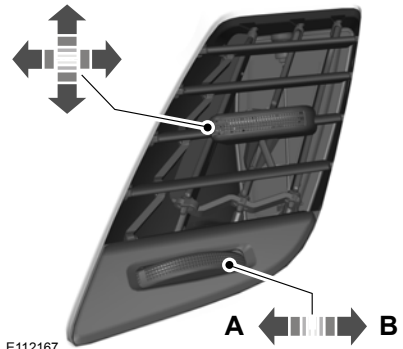

- A Close
- B Open

### Side air vent



# Climate control

## MANUAL CLIMATE CONTROL

### Air distribution control

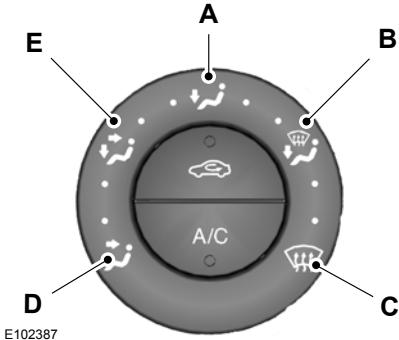

- A Footwell
- B Footwell and windscreen
- C Windscreen
- D Face level
- E Face level and footwell

You can set the air distribution control to any position between the symbols.

### Blower

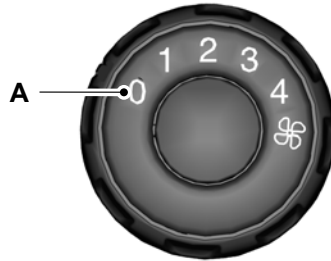

- A Off

**Note:** If you switch the blower off, the windscreen may mist up.

### Recirculated air



Press the button to toggle between outside air and recirculated air.

### System settings

**Note:** Set all controls to the positions shown.

### Heating the interior quickly

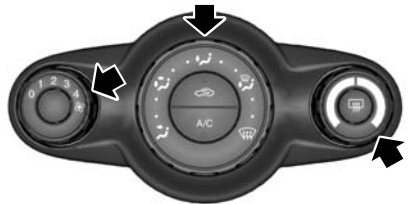

# Climate control

## Ventilation

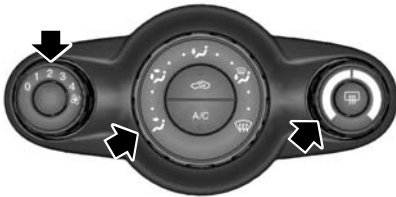

E102394

Set the air distribution control, blower and air vents to suit your requirements.

## Switching the air conditioning on and off



If you turn the blower off, the air conditioning will turn off. When you turn the blower on again, the air conditioning will come on automatically.

## Cooling with outside air

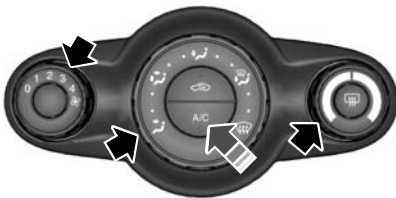

E102395

## Cooling the interior quickly

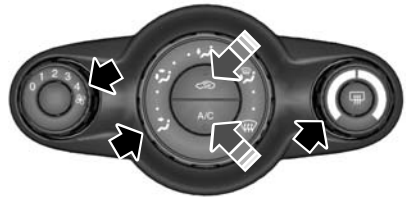

E102396

## Defrosting and demisting the windscreen

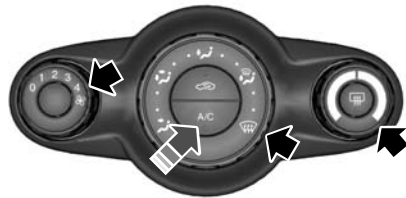

E102397

When the temperature is above 4°C (39°F), the air conditioning will switch on automatically. Make sure that the blower is on. The indicator in the switch will illuminate during defrosting and demisting.

If you move the air distribution control to a position other than **C**, the **A/C** will remain on.

You can switch the air conditioning and recirculated air on and off while the air distribution control is set to position **C**.

If necessary, switch the heated windows on. See **Heated windows and mirrors** (page 80).

# Climate control

## Reducing interior air humidity

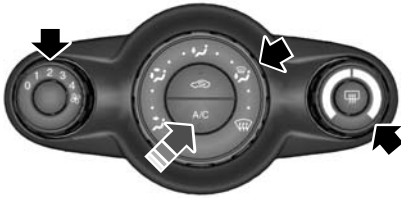

E102398

## AUTOMATIC CLIMATE CONTROL

The system controls the temperature, amount and distribution of the air flow automatically and adjusts them according to the driving and weather conditions. Pressing the **AUTO** button once switches on the auto mode.

**Note:** Avoid adjusting the settings when the vehicle interior is extremely hot or cold. The automatic climate control adjusts to the current circumstances automatically. For the system to function properly, the side and centre vents should be fully open.

**Note:** The sunload sensor is located on top of the instrument panel. Do not cover the sensor with any objects.

**Note:** At low outside temperatures, when the system is in auto mode, the air stream will be directed to the windscreen and the side windows as long as the engine is cold.

## Setting the temperature



E102706

You can set the temperature between 16°C and 28°C in steps of 0.5°C. In position **LO** (below 16°C) the system will switch to permanent cooling, in **HI** (above 28°C) to permanent heating, and not regulate a stable temperature.

## Blower

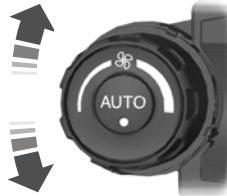

E102731

The blower setting is indicated in the display.

To return to auto mode, press the **AUTO** button.

## Air distribution

To adjust air distribution, press the desired button. Any combination of settings can be selected simultaneously.

# Climate control

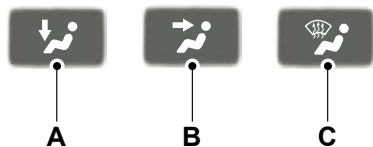

E70308

- A Footwell
- B Face level
- C Windscreen

When you select windscreen defrosting and demisting, **A**, **B** and **C** switch off automatically and the air conditioning switches on. Outside air will flow into the vehicle. You cannot select recirculated air.

## Windscreen defrosting and demisting



Press the windscreen defrosting and demisting button. Outside air will flow into the vehicle. Air conditioning is automatically selected. As long as the air distribution is set to this position, you cannot select recirculated air.

The blower speed and the temperature control operate automatically and cannot be adjusted manually. The blower is set to high speed and the temperature to **HI**.

When you select windscreen defrosting and demisting, the heated screens switch on automatically and switch off after a short time.

To return to auto mode, press the **AUTO** button.

## Switching the air conditioning on and off



Press the **A/C** button to switch the air conditioning on and off. **A/C OFF** appears in the display when the air conditioning is switched off.

**A/C ON** appears in the display when the air conditioning is switched on.

## Recirculated air



Press the recirculated air button to toggle between outside air and recirculated air.

**Note:** *When the system is in auto mode and the interior and exterior temperatures are quite hot, the system selects recirculated air automatically to maximise cooling of the interior. Once the selected temperature is reached, the system will reselect outside air automatically.*

## Switching off the automatic climate control



Press the **OFF** button.

When switched off, the heating, ventilation and air conditioning system is switched off and recirculated air is selected.

# Climate control

---

## HEATED WINDOWS AND MIRRORS

### Heated windows

Use the heated windows to defrost or demist the windscreen or rear window.

**Note:** *The heated windows operate only when the engine is running.*

### Heated windscreen



### Heated rear window



### Heated exterior mirrors

Electric exterior mirrors are fitted with a heating element that will defrost or demist the mirror glass. They will switch on automatically when you switch the heated rear window on.

# Seats

## SITTING IN THE CORRECT POSITION

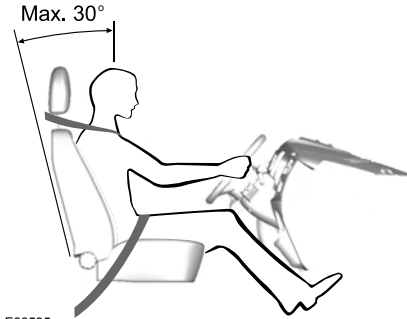

E66595

### WARNINGS



Do not adjust the seats when the vehicle is moving.



Only when you use the seat belt properly, can it hold you in a position that allows the airbag to achieve its optimum effect.

When you use them properly, the seat, head restraint, seat belt and airbags will provide optimum protection in the event of a collision. We recommend that you:

- sit in an upright position with the base of your spine as far back as possible.
- do not recline the seatback more than 30 degrees.
- adjust the head restraint so that the top of it is level with the top of your head and as far forwards as possible, remaining comfortable.
- keep sufficient distance between yourself and the steering wheel. We recommend a minimum of 250 millimetres (10 inches) between your breastbone and the airbag cover.

- hold the steering wheel with your arms slightly bent.
- bend your legs slightly so that you can press the pedals fully.
- position the shoulder strap of the seat belt over the centre of your shoulder and position the lap strap tightly across your hips.

Make sure that your driving position is comfortable and that you can maintain full control of your vehicle.

## HEAD RESTRAINTS

### Adjusting the head restraint

#### WARNINGS



Raise the rear head restraint when the rear seat is occupied by a passenger.



When using a forward facing child restraint on a rear seat, always remove the head restraint from that seat.

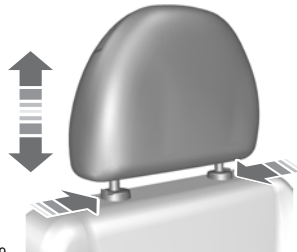

E66539

Adjust the head restraint so that the top of it is level with the top of your head.

### Removing the head restraint

Press the locking buttons and remove the head restraint.

# Seats

## MANUAL SEATS

### WARNINGS



Do not use any accessory seat covers that are not specifically designed for seats with side airbags. These seat covers must be fitted by properly trained technicians.



Do not adjust the seats while the vehicle is moving.

## Moving the seats forwards or backwards

### WARNING



Rock the seat backwards and forwards after releasing the lever to make sure that it is fully engaged in its catch.

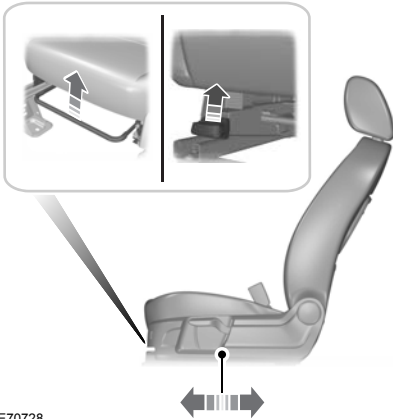

E70728

## Folding the seatback forwards - 3-door

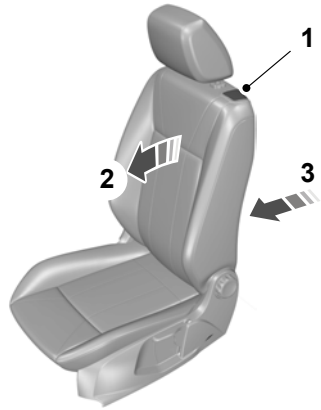

E112675

1. Pull the locking lever to release the seatback.

**Note:** Do not hold on to the locking lever when moving the seat.

2. Push the seatback forwards to lock it in the folded position.

3. Continue to push the seatback to slide the seat forwards.

## Returning the seatback to the seating position - 3-door

### WARNING



Do not place any objects behind the seatback which could prevent the engagement of the seat lock.

# Seats

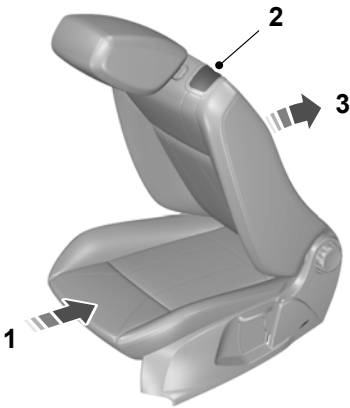

E112676

1. Slide the seat backwards to the end stop (memory position) or desired forward seating position.

**Note:** *The memory function is only available on the driver's seat.*

2. Pull the locking lever to release the seatback.
3. Unfold the seatback until it locks with a distinct click.

## Adjusting the lumbar support



E70729

## Adjusting the height of the driver's seat

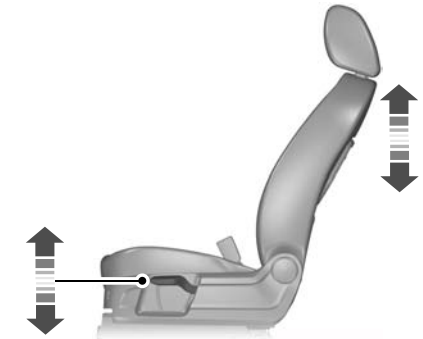

E70730

Each pull or press on the lever will raise or lower the height by a small amount.

## Adjusting the angle of the seatback

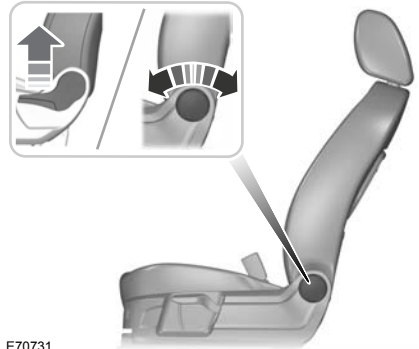

E70731

# Seats

## REAR SEATS

### Folding the seatbacks down

#### WARNING



When folding the seatbacks down, take care not to get your fingers caught between the seatback and seat frame.

#### CAUTIONS



Do not attempt to fold the rear seat cushion forwards.



Lower the head restraints. See **Head restraints** (page 81).



E102532

1. Press the unlock buttons down and hold them there.
2. Push the seatback forwards.

#### WARNINGS



When folding the seatbacks up, make sure that the belts are visible to an occupant and not caught behind the seat.



Make sure that the seats and the seatbacks are secure and fully engaged in their catches.

## HEATED SEATS

#### CAUTION



Operating this function with the engine off will drain the battery.



E112664

The seat heating will operate only when the ignition is switched on.

The maximum temperature is reached after five or six minutes. It is regulated thermostatically.

The seat heating will remain on until either the heated seat switch or the ignition is turned off.

# Convenience features

## SUN VISORS

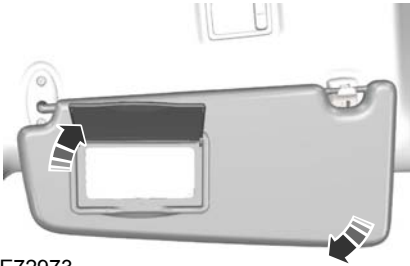

E72973

## CLOCK

To adjust the clock, switch the ignition on and press buttons **H** or **M** as necessary.

## CUP HOLDERS

### WARNING



Do not place hot drinks in the cup holders when the vehicle is moving.

## CIGAR LIGHTER

### CAUTIONS



If you use the socket when the engine is not running, the battery may discharge.



Do not hold the cigar lighter element pressed in.

**Note:** You can use the socket to power 12 volt appliances that have a maximum current rating of 15 Amperes. Use only Ford accessory connectors or connectors specified for use with SAE standard sockets.

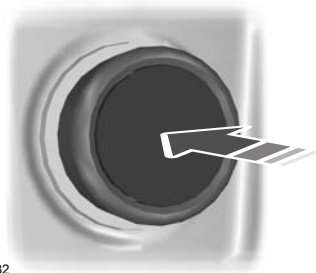

E103382

Press the element in to use the cigar lighter. It will pop out automatically.

## STORAGE COMPARTMENTS

### WARNING



Do not drive with any storage compartment lid open. Make sure that you secure the lid before setting off.

### CAUTION



Do not keep heat-sensitive items and liquids in any storage compartment.



E72980

## Convenience features

### MAP POCKETS

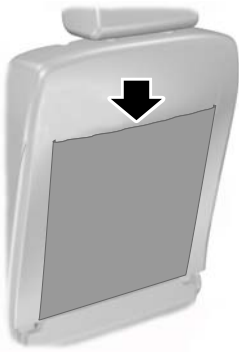

E74686

### TOLL READER

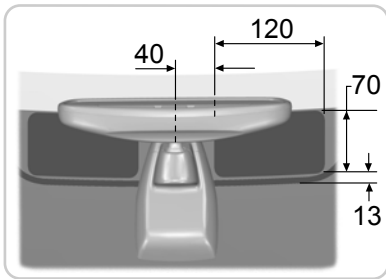

E99272

On vehicles with an anti-heat windscreen, toll readers should be placed in the area as shown (all measurements shown in millimetres), otherwise communication performance with toll stations may be reduced.

The toll reader should be placed on the passenger side to prevent the reader from obscuring the driver's vision (e.g. at traffic lights).

### AUXILIARY INPUT (AUX IN) SOCKET

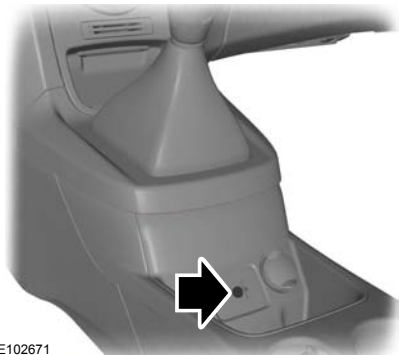

E102671

See **Auxiliary input (AUX IN) socket** (page 176).

## Convenience features

### USB PORT

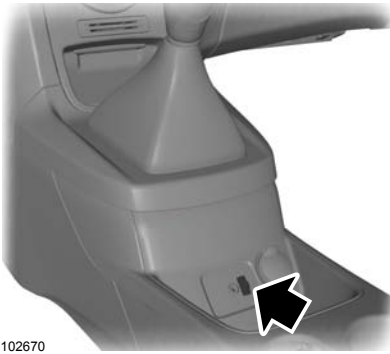

E102670

See **Connectivity** (page 198).

### SATELLITE NAVIGATION UNIT HOLDER

#### Adjusting the holder

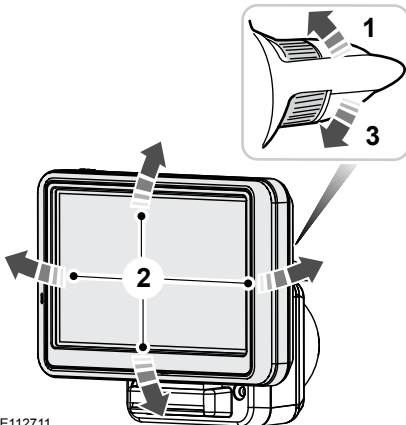

E112711

1. Unlock.
2. Adjust the holder to the desired position.

3. Lock.

**Note:** Make sure that the navigation unit holder is locked in position.

### FLOOR MATS

#### WARNING



When using the floor mats, always make sure the floor mat is properly secured using the appropriate fixings and positioned so that it does not interfere with the operation of the pedals.

# Starting the engine

## GENERAL INFORMATION

### General points on starting

If the battery has been disconnected the vehicle may exhibit some unusual driving characteristics for approx. 8 kilometres (5 miles) after reconnecting the battery.

This is because the engine management system must realign itself with the engine. Any unusual driving characteristics during this period may be disregarded.

### Starting the engine by towing or pushing

#### WARNING



To prevent damage you must not push or tow start your vehicle. Use booster cables and a booster battery. See **Using booster cables** (page 139).

## IGNITION SWITCH

#### WARNING



Never return the key to position **O** or **I** when the vehicle is in motion.



E72128

**O** The ignition is off.

**I** The ignition and all main electrical circuits are disabled.

**Note:** Do not leave the ignition key in this position for too long to avoid discharging the battery.

**II** The ignition is switched on. All electrical circuits are operational. Warning lamps and indicators illuminate. This is the key position when driving. You must also select it when being towed.

**III** The starter motor is activated. Release the key as soon as the engine starts.

## KEYLESS STARTING

#### WARNINGS



The keyless starting system may not function if the key is close to metal objects or electronic devices such as mobile phones.



Always check that the steering wheel lock is deactivated before attempting to move your vehicle.

**Note:** A valid passive key must be located inside the vehicle to switch the ignition on and start the engine.

**Note:** To start your engine you must also fully depress the brake or clutch pedal, depending on the transmission fitted.



E85766

### Ignition on

Press the start button once. All electrical circuits are operational, warning lamps and indicators illuminate.

# Starting the engine

---

## Starting with automatic transmission

**Note:** Releasing the brake pedal during engine start will stop the engine cranking and return to ignition on.

1. Make sure the transmission is in **P** or **N**.
2. Fully depress the brake pedal.
3. Briefly press the start button.

## Starting with manual transmission

**Note:** Releasing the clutch pedal during engine start will stop the engine cranking and return to ignition on.

1. Fully depress the clutch pedal.
2. Briefly press the start button.

## Starting a diesel engine

**Note:** Engine cranking will not commence until the engine glow plug cycle has been completed. This may take several seconds in extremely cold conditions.

**Note:** Continue to press the clutch or brake pedal until engine cranking begins.

## Failure to start

The passive starting system will not function if:

- The passive key frequencies are jammed.
- The passive key battery is flat.

If you are unable to start your vehicle carry out the following procedure.

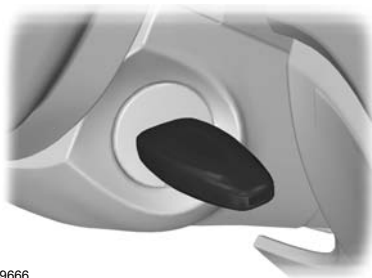

E99666

1. Hold the key next to the steering column shroud exactly as shown.
2. With the key in this position you can use the start button to switch the ignition on and start your vehicle.

## Stopping the engine with the vehicle stationary

**Note:** The ignition, all electrical circuits, warning lamps and indicators will be switched off.

### Manual transmission

Press the start button.

### Automatic transmission

1. Move the selector lever to position **P**.
2. Press the start button.

## Stopping the engine when the vehicle is moving

### WARNING



Switching off the engine when the vehicle is still moving will result in a loss of brake and steering assistance. The steering will not be locked, but higher effort will be required. When the ignition is switched off some electrical circuits, warning lamps and indicators may also be OFF.

---

# Starting the engine

---

Press and hold the start button for two seconds, or press three times within three seconds.

## STEERING WHEEL LOCK

### WARNING



Always check that the steering is unlocked before attempting to move your vehicle.

---

## Vehicles without keyless starting

To activate the steering wheel lock;

1. Remove the key from the ignition switch.
2. Turn the steering wheel.

## Vehicles with keyless starting

**Note:** *The steering wheel lock will not activate when the ignition is on or the vehicle is moving.*

Your vehicle has an electronically controlled steering wheel lock. This operates automatically.

The steering wheel lock will activate after a short period of time once you have parked your vehicle and the passive key is outside of the vehicle.

## Deactivating the steering wheel lock

Switch the ignition on, or:

Vehicles with automatic transmission

- Press the brake pedal.

Vehicles with manual transmission

- Press the clutch pedal.

## STARTING A PETROL ENGINE

**Note:** *You can only operate the starter for a maximum of 30 seconds at a time.*

## Cold or hot engine

### All vehicles

### CAUTION



When the temperature is below -20°C (-4°F), switch the ignition on for at least one second before starting the engine. This will make sure that the maximum fuel pressure is established for starting the engine.

---

## Vehicles with manual transmission

**Note:** *Do not touch the accelerator pedal.*

1. Fully depress the clutch pedal.
2. Start the engine.
3. If the engine does not start, fully depress the brake and clutch pedals.

## Vehicles with automatic transmission

**Note:** *Do not touch the accelerator pedal.*

1. Select park or neutral.
2. Fully depress the brake pedal.
3. Start the engine.

### All vehicles

If the engine does not start within 15 seconds, wait for a short period and try again.

If the engine does not start after **three** attempts, wait 10 seconds and follow the **Flooded engine** procedure.

# Starting the engine

If you have difficulty starting the engine when the temperature is below  $-25^{\circ}\text{C}$  ( $-13^{\circ}\text{F}$ ), press the accelerator pedal between  $\frac{1}{4}$  to  $\frac{1}{2}$  of its travel and try again.

## Flooded engine

### Vehicles with manual transmission

1. Fully depress the clutch pedal.
2. Fully depress the accelerator pedal and hold it there.
3. Start the engine.

### Vehicles with automatic transmission

1. Select park or neutral.
2. Fully depress the accelerator pedal and hold it there.
3. Fully depress the brake pedal.
4. Start the engine.

## All vehicles

If the engine does not start, repeat the **Cold or hot engine** procedure.

## Engine idle speed after starting

The speed at which the engine idles immediately after starting will vary depending on the engine temperature.

If the engine is cold then the idle speed will automatically be increased in order to heat the catalytic converter as quickly as possible. This ensures that vehicle emissions are kept to an absolute minimum.

The idle speed will slowly decrease to the normal level as the catalytic converter warms up.

## STARTING A DIESEL ENGINE

### Cold or hot engine

#### All vehicles

**Note:** When the temperature is below  $-15^{\circ}\text{C}$  ( $5^{\circ}\text{F}$ ), you may need to crank the engine for up to 25 seconds. If you consistently operate the vehicle in such temperatures, we recommend that you have an engine block heater fitted.

**Note:** Continue cranking the engine until it starts.

**Note:** You can only operate the starter for a maximum of 30 seconds at a time.



Switch the ignition on and wait until the glow plug indicator goes off.

#### Vehicles with manual transmission

**Note:** Do not touch the accelerator pedal.

1. Fully depress the clutch pedal.
2. Start the engine.
3. If the engine does not start, fully depress the brake and clutch pedals.

#### Vehicles with automatic transmission

1. Select park or neutral.
2. Fully depress the brake pedal.
3. Start the engine.

## DIESEL PARTICULATE FILTER (DPF)

The DPF forms part of the emissions reduction systems fitted to your vehicle. It filters harmful diesel particulates (soot) from the exhaust gas.

# Starting the engine

---

## Regeneration

### WARNING



Do not park or idle your vehicle over dry leaves, dry grass or other combustible materials. The DPF regeneration process creates very high exhaust gas temperatures and the exhaust will radiate a considerable amount of heat during and after DPF regeneration, and after you have switched the engine off. This is a potential fire hazard.

---

### CAUTION



Avoid running out of fuel.

---

**Note:** *After you have switched your engine off the fans may continue to run for a short period of time.*

Unlike a normal filter which requires periodic replacement, the DPF has been designed to regenerate, or clean itself to maintain operating efficiency. The regeneration process takes place automatically. However, some driving conditions mean that you may need to support the regeneration process.

If you drive only short distances or your journeys contain frequent stopping and starting, where there is increased acceleration and deceleration, occasional trips with the following conditions will assist the regeneration process:

- Drive your vehicle at a constant speed, preferably on a main road or motorway, for up to 20 minutes.
- Avoid prolonged idling and always observe speed limits and road conditions.

- Do not switch off the ignition.
- Use a lower gear than normal to maintain a higher engine speed during this journey, where appropriate.

# Fuel and refuelling

## SAFETY PRECAUTIONS

### WARNINGS



Stop refuelling after the fuel nozzle stops the second time. Additional fuel will fill the expansion space in the fuel tank which could lead to fuel overflowing. Fuel spillage could be hazardous to other road users.



Do not use any kind of flames or heat near the fuel system. The fuel system is under pressure. There is a risk of injury if the fuel system is leaking.

## FUEL QUALITY - PETROL

### CAUTION



Do not use leaded petrol or petrol with additives containing other metallic compounds (e.g. manganese-based). They could damage the emission system.

**Note:** We recommend that you use only high quality fuel without additives or other engine treatments.

Use **minimum 95 octane unleaded** petrol that meets the specification defined by **EN 228**, or equivalent.

## FUEL QUALITY - DIESEL

### WARNING



Do not mix diesel with oil, petrol or other liquids. This could cause a chemical reaction.

### CAUTIONS



Do not add kerosene, paraffin or petrol to diesel. This could cause damage to the fuel system.

### CAUTIONS



Use diesel that meets the specification defined by **EN 590**, or the relevant national specification.

**Note:** We recommend that you use only high quality fuel.

**Note:** The use of additives or other engine treatments not approved by Ford is not recommended.

**Note:** We do not recommend the prolonged use of additives intended to prevent fuel waxing.

## Long-term storage

Most diesel fuels contain bio-diesel, it is recommended to fill the tank with purely mineral diesel (where available) or add an anti-oxidant prior to long-term storage of your vehicle exceeding two months. Your dealer can help you with a suitable anti-oxidant.

## FUEL FILLER FLAP

### WARNINGS



Take care when refuelling to avoid spilling any residual fuel from the fuel nozzle.



Do not use any kind of flames or heat near the fuel system. The fuel system is under pressure. There is a risk of injury if the fuel system is leaking.

### CAUTION



If you use a high pressure spray to wash your vehicle, only spray the fuel filler flap briefly from a distance not less than 20 centimetres (8 inches).

# Fuel and refuelling

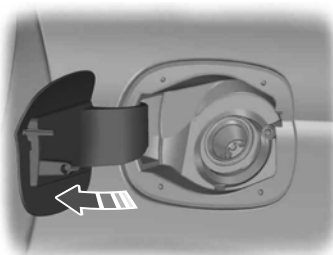

E103203

Press the flap to open it. Open the flap fully until it engages.

When you insert the fuel nozzle, a spring loaded inhibitor will open if the correct size nozzle is detected. This helps to avoid filling up with the wrong fuel.

## WARNING



Stop refuelling after the fuel nozzle stops the second time. Additional fuel will fill the expansion space in the fuel tank which could lead to fuel overflowing. Fuel spillage could be hazardous to other road users.

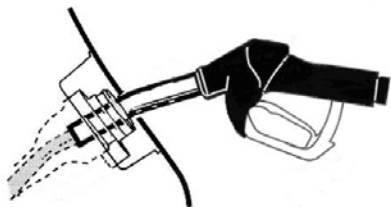

E119080

Insert the fuel nozzle up to and including the first notch on the nozzle. Keep it resting on the cover of the fuel pipe opening.

## WARNING



We recommend that you wait at least 10 seconds before removing the fuel nozzle to allow any residual fuel to drain into the fuel tank.

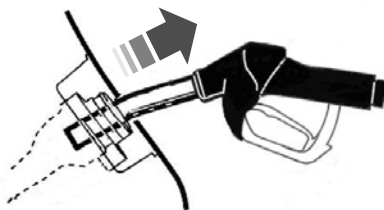

E119081

Slightly raise the fuel nozzle to remove it.

## Vehicles with tyre repair kit

A funnel is located in the spare wheel well. Use this when refilling with a fuel can.

## Vehicles without tyre repair kit

A funnel is located in the glove box. Use this when refilling with a fuel can.

## CATALYTIC CONVERTER

### WARNING







Do not park or idle your vehicle over dry leaves, dry grass or other combustible materials. The exhaust will radiate a considerable amount of heat during use, and after you have switched the engine off. This is a potential fire hazard.

# Fuel and refuelling

## Driving with a catalytic converter

### CAUTIONS

-  Avoid running out of fuel.
-  Do not crank the engine for long periods.
-  Do not run the engine when a spark plug lead is disconnected.
-  Do not push-start or tow-start your vehicle. Use booster cables. See **Using booster cables** (page 139).
-  Do not switch the ignition off when driving.

## REFUELLING

### CAUTION

-  Do not attempt to start the engine if you have filled the fuel tank with the incorrect fuel. This could damage the engine. Have the system checked by a properly trained technician immediately.

## TECHNICAL SPECIFICATIONS

### Fuel consumption figures

Variant	Urban	Extra-urban	Combined	CO2 emissions
	l/100 km (mpg)	l/100 km (mpg)	l/100 km (mpg)	g/km
1.25L Duratec-16V (Sigma) (44kW/60PS) Stage V	7.3 (38.7)	4.4 (64.2)	5.5 (51.4)	127
1.25L Duratec-16V (Sigma) (60kW/82PS) Stage V	7.4 (38.2)	4.5 (62.8)	5.6 (50.4)	129
1.4L Duratec-16V (Sigma) (71kW/96PS) Stage IV, manual transmission	7.5 (37.7)	4.6 (61.4)	5.7 (49.6)	133

## FUEL CONSUMPTION

The CO<sub>2</sub> and fuel consumption figures are derived from laboratory tests according to EEC Directive 80/1268/EEC and subsequent amendments and are carried out by all vehicle manufacturers.

They are intended as a comparison between makes and models of vehicles. They are not intended to represent the real world fuel consumption you may get from your vehicle. Real world fuel consumption is governed by many factors including; driving style, high speed driving, stop/start driving, air conditioning usage, the accessories fitted and towing etc.

Your Ford dealer can give you advice on improving your fuel consumption.

## Fuel and refuelling

Variant	Urban	Extra-urban	Combined	CO2 emissions
	l/100 km (mpg)	l/100 km (mpg)	l/100 km (mpg)	g/km
1.4L Duratec-16V (Sigma) (71kW/96PS) Stage V, manual transmission	7.6 (37.2)	4.7 (60.1)	5.8 (48.7)	133
1.4L Duratec-16V (Sigma) (71kW/96PS) Stage IV, automatic transmission	8.9 (31.7)	5.1 (55.4)	6.5 (43.5)	154
1.4L Duratec-16V (Sigma) (71kW/96PS) Stage V, automatic transmission	8.9 (31.7)	5.2 (54.3)	6.6 (42.8)	154
1.6L Duratec-16V Ti-VCT (Sigma) (88kW/120PS) Stage V	7.9 (35.8)	4.6 (61.4)	5.8 (48.7)	134
1.6L Duratec-16V Ti-VCT (Sigma) (99kW/134PS) Stage V	8.0 (35.3)	4.8 (58.9)	5.9 (47.9)	139
1.4L Duratorq-TDCi (DV) Diesel (50kW/68PS) Stage IV	5.3 (53.3)	3.5 (80.7)	4.2 (67.3)	110
1.4L Duratorq-TDCi (DV) Diesel (51kW/70PS) Stage V	4.8 (58.9)	3.6 (78.5)	4.1 (68.9)	107
1.6L Duratorq-TDCi (DV) Diesel (55kW/75PS) Stage V	4.9 (57.6)	3.6 (78.5)	4.1 (68.9)	107
1.6L Duratorq-TDCi (DV) Diesel (70kW/95PS) Stage V	4.9 (57.6)	3.6 (78.5)	4.1 (68.9)	107
1.6L Duratorq-TDCi ECONetic (70kW/95PS) Stage V	4.6 (61.4)	3.2 (88.3)	3.7(76.3)	98

# Transmission

## MANUAL TRANSMISSION

### Selecting reverse gear

#### CAUTIONS

- ⚠ Do not engage reverse gear when the vehicle is moving. This can cause damage to the transmission.
- ⚠ Fully depress the clutch pedal and wait for three seconds before you select reverse gear.

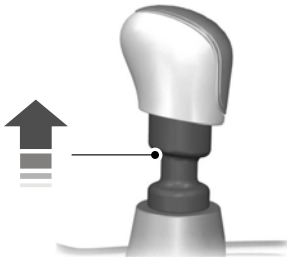

E99067

On some vehicles it is necessary to raise the collar whilst selecting reverse gear.

## AUTOMATIC TRANSMISSION

### General information

This transmission also allows you to change gear manually (similar to a manual transmission).

### Selector lever positions



E78310

- P Park
- R Reverse
- N Neutral
- D Drive
- M Manual shifting

#### WARNING



Apply the brakes before moving the selector lever and keep them applied until you are ready to move off.

**Note:** A cold engine has a higher idle speed. This will increase the tendency for your vehicle to **creep** when you have selected a drive gear.

Press the button on the selector lever to select reverse and park.

The selector lever position will be shown in the information display.

### Park

#### WARNINGS



Select park only when your vehicle is stationary.

# Transmission

## WARNINGS



**Apply the parking brake and select park before leaving your vehicle.** Make sure that the selector lever is latched in position.

\_\_\_\_\_

**Note:** An audible warning will sound if you open the driver's door and you have not selected park.

**Note:** The battery saver will deactivate the warning chime after a period of time.

In this position, power is not transmitted to the drive wheels and the transmission is locked. You can start the engine with the selector lever in this position.

## Reverse

### WARNING



Select reverse only when your vehicle is stationary and the engine is at idle speed.

## Neutral

In this position, power is not transmitted to the drive wheels but the transmission is not locked. You can start the engine with the selector lever in this position.

## Drive

Select drive to shift automatically through the forward gears.

## Manual shifting

**Note:** A shift will occur only when the vehicle speed and the engine speed are appropriate.

Select manual shifting to shift manually through the forward gears. Push the selector lever forwards to shift down and pull it backwards to shift up.

## WARNING



Do not hold the selector lever permanently in - or +.

Gears can be skipped by moving the selector lever repeatedly at short intervals.

Manual mode also provides a kickdown function. See **Kickdown**.

The transmission will automatically downshift when the engine speed is too low and upshift when to high.

## Drive modes

The transmission will select the appropriate gear for optimum performance based on ambient temperature, road gradient, vehicle load and driver input.

## Hints on driving with an automatic transmission

### Moving off

### WARNING



It is not possible to tow-start or push-start a vehicle fitted with an automatic transmission. See **Using booster cables** (page 139).

1. Release the parking brake.
2. Release the brake pedal and press the accelerator pedal.

### Stopping

1. Release the accelerator pedal and press the brake pedal.
2. Apply the parking brake.

# Transmission

## Kickdown

Press the accelerator pedal fully with the selector lever in the drive position to select the next lowest gear for optimum performance. Release the accelerator pedal when you no longer require kickdown.

## Emergency park position release lever

Use the lever to move the selector lever from the park position in the event of an electrical malfunction or if your vehicle has a flat battery.

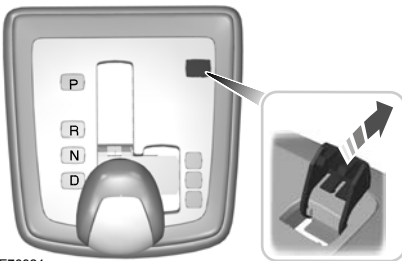

E78321

### CAUTION



Take care when lifting up the hinged cover.

Lift up the hinged cover in the centre console next to the selector lever with a small flat bladed tool.



E78322

With a suitable object push down the locking lever in the slot and simultaneously move the selector lever out of the **P** position.

**Note:** If position **P** is selected again, this procedure must be repeated.

# Brakes

---

## PRINCIPLE OF OPERATION

### Disc brakes

Wet brake discs result in reduced braking efficiency. Dab the brake pedal when driving from a car wash to remove the film of water.

### ABS

#### WARNING



The ABS does not relieve you of your responsibility to drive with due care and attention.

The ABS helps you to maintain full steering and directional stability when you brake heavily in an emergency, by preventing the road wheels from locking.

## HINTS ON DRIVING WITH ABS

When the ABS is operating, the brake pedal will pulse. This is normal. Maintain pressure on the brake pedal.

The ABS will not eliminate the dangers inherent when:

- you drive too close to the vehicle in front of you.
- the vehicle is aquaplaning.
- you take corners too fast.
- the road surface is poor.

## PARKING BRAKE

### All vehicles

#### WARNING



Vehicles with an automatic transmission should always be left with the selector lever in position **P**.

- Press the foot brake pedal firmly.
- Pull the parking brake lever up smartly to its fullest extent.
- Do not press the release button while pulling the lever up.
- If your vehicle is parked on a hill and facing uphill, select first gear and turn the steering wheel away from the kerb.
- If your vehicle is parked on a hill and facing downhill, select reverse gear and turn the steering wheel towards the kerb.

To release the parking brake, press the brake pedal firmly, pull the lever up slightly, depress the release button and push the lever down.

# Stability control

## PRINCIPLE OF OPERATION

### Electronic stability programme (ESP)

#### WARNING



ESP does not relieve you of your responsibility to drive with due care and attention.

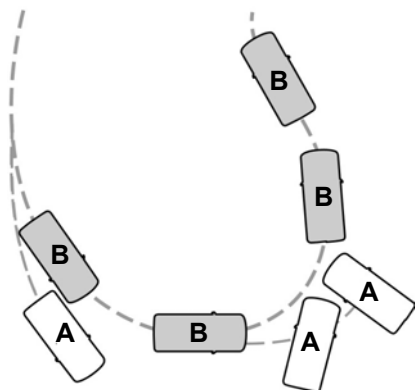

E72903

- A without ESP
- B with ESP

The ESP supports stability when the vehicle starts to slide away from your intended path. This is performed by braking individual wheels and reducing engine torque as needed.

The system also provides an enhanced traction control function by reducing engine torque if the wheels spin when you accelerate. This improves your ability to pull away on slippery roads or loose surfaces, and improves comfort by limiting wheel spin in hairpin bends.

### Stability control (ESP) warning lamp

The ESP warning lamp will flash when the system is operating. See **Warning lamps and indicators** (page 59).

### Emergency brake assist

#### WARNING



Emergency brake assist does not relieve you of your responsibility to drive with due care and attention.

Emergency brake assist will detect when you brake heavily by measuring the rate at which you press the brake pedal. It will provide maximum braking efficiency as long as you press the pedal. Emergency brake assist can reduce stopping distances in critical situations.

## USING STABILITY CONTROL

**Note:** The system will be switched on automatically every time you switch the ignition on.

### Vehicles with stability control (ESP) switch

Press and hold the switch for one second. The switch will illuminate. A message will be shown in the display. See **Information messages** (page 70).

Press the switch again to turn the system on.

For item location: See **Quick start** (page 10).

# Parking aid

## PRINCIPLE OF OPERATION

### WARNING



The parking aid does not relieve you of your responsibility to drive with due care and attention.

### CAUTIONS



Vehicles fitted with a trailer tow module not approved by us may not correctly detect obstacles.



The sensors may not detect objects in heavy rain or other conditions that cause disruptive reflections.



The sensors may not detect objects with surfaces that absorb ultrasonic waves.



The parking aid does not detect obstacles moving away from the vehicle. They will only be detected shortly after they start to move towards the vehicle again.



Take particular care when reversing with a tow ball arm or rear fitted accessories e.g. a bicycle carrier, as the rear parking aid will only indicate the distance from the bumper to the obstacle.



If you use a high pressure spray to wash your vehicle, only spray the sensors briefly from a distance not less than 20 centimetres (8 inches).

**Note:** *On vehicles fitted with a tow ball arm, the parking aid is deactivated automatically when any trailer lamps (or lighting boards) are connected to the 13-pin socket via a trailer tow module we have approved.*

**Note:** *Keep the sensors free from dirt, ice and snow. Do not clean with sharp objects.*

**Note:** *The parking aid may emit false tones if it detects a signal using the same frequency as the sensors or if the vehicle is fully laden.*

**Note:** *The outer sensors may detect the side walls of a garage. If the distance between the outer sensor and the side wall remains constant for three seconds, the tone will switch off. As you continue, the inner sensors will detect rearward objects.*

## USING THE PARKING AID - VEHICLES WITH: REAR PARKING AID

### WARNING



The parking aid does not relieve you of your responsibility to drive with due care and attention.

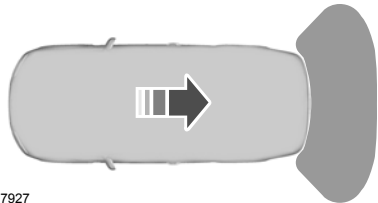

E77927

The parking aid is automatically activated when you select reverse gear with the ignition switched on.

You will hear an intermittent tone at a distance of approximately 150 centimetres (59 inches) between the obstacle and rear bumper and approximately 50 centimetres (20 inches) to the side. Decreasing the distance accelerates the intermittent tone. A continuous tone will start at a distance of less than 30 centimetres (11 inches) to the rear bumper.

# Parking aid

**Note:** If a high pitch tone is heard for three seconds, this indicates a malfunction. The system will be disabled. Have the system checked by a properly trained technician.

## USING THE PARKING AID - VEHICLES WITH: FRONT AND REAR PARKING AID

### WARNING



The parking aid does not relieve you of your responsibility to drive with due care and attention.

### Switching the parking aid on and off

The parking aid is per default off. To switch the parking aid on, select reverse gear or press the switch in the instrument panel. For item location: See **Quick start** (page 10).

The light in the switch illuminates when the parking aid is activated.

To turn it off, press the switch again or disengage reverse gear.

**Note:** The parking aid switches off automatically after a period of 20 seconds if no obstacle has been detected by the front bumper sensors.

## Manoeuvring with the parking aid

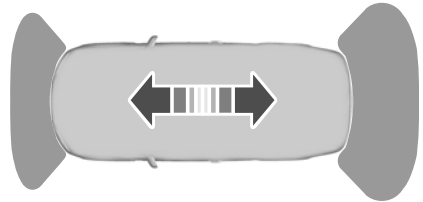

E72902

You will hear an intermittent tone at a distance of approximately 150 centimetres (59 inches) between the obstacle and rear bumper, approximately 80 centimetres (31 inches) between the obstacle and front bumper and approximately 50 centimetres (20 inches) to the side. Decreasing the distance accelerates the intermittent tone. A continuous tone will start at a distance of less than 30 centimetres (11 inches) to the front and rear bumper.

You will hear an alternating tone from the front and rear if obstacles are closer than 30 centimetres (11 inches) to the front and rear bumpers.

**Note:** If a high pitch tone is heard for three seconds and the light in the switch is flashing, this indicates a malfunction. The system will be disabled. Have the system checked by a properly trained technician.

# Rear view camera

## PRINCIPLE OF OPERATION

The camera is a visual aid for use when reversing.

### WARNING



The camera does not relieve you of your responsibility to drive with due care and attention.

### CAUTIONS



If you use a high pressure spray to wash your vehicle, only spray the camera briefly from a distance not less than 20 centimetres (8 inches).



Do not apply pressure to the camera.

**Note:** *Keep the camera free from dirt, ice and snow. Do not clean with sharp objects, degreaser, wax or organic products. Use only a soft cloth.*

During operation, guide lines appear in the display which represent your vehicle's path and approximate distance from rearward objects.

## USING THE REAR VIEW CAMERA

### WARNINGS



The operation of the camera may vary depending on the ambient temperature, vehicle and road conditions.



The distances shown in the display may differ from the actual distance.



Do not place objects in front of the camera.

The camera is located on the luggage compartment lid near the handle.

## Activating the rear view camera

### CAUTION



The camera may not detect objects that are close to the vehicle.

With the ignition switched on, engage reverse gear. The image is displayed in the interior mirror.

The camera may not operate correctly in the following conditions:

- Dark areas.
- Intense light.
- If the ambient temperature increases or decreases rapidly.
- If the camera is wet, for example in rain or high humidity.
- If the camera's view is obstructed, for example by mud.

## Using the display

### CAUTIONS



Obstacles above the camera position will not be shown. Inspect the area behind your vehicle if necessary.



Marks are for general guidance only, and are calculated for vehicles in maximum load conditions on an even road surface.

**Note:** *When reversing with a trailer, the lines on the screen show the vehicle direction and not the trailer.*

# Rear view camera

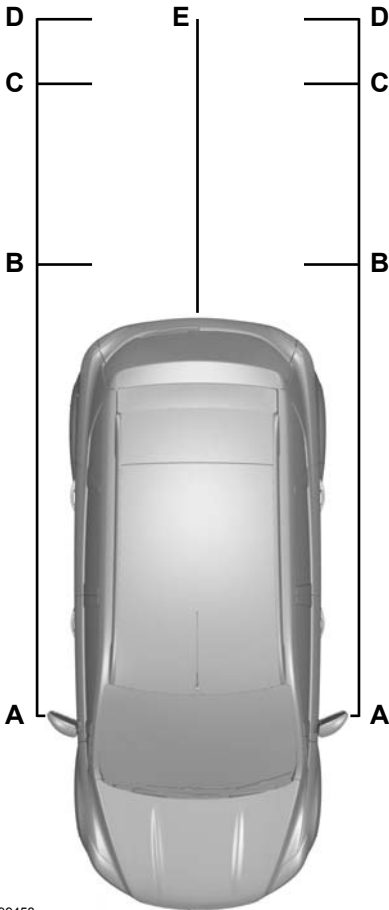

E99458

- A Exterior mirror clearance - 0.1 metre (4 inches)
- B Red - 0.3 metre (12 inches)
- C Amber - 1 metre (39 inches)

- D Amber - 2 metres (79 inches)
- E Amber - centre line of the projected vehicle path

The lines show a projected vehicle path based on the distance from the exterior mirrors and rear bumper.

## Switching the rear view camera on and off

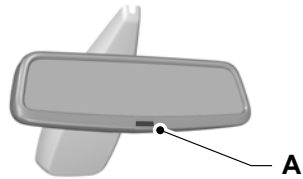

E128967

- A On and off button

Press button **A** to manually switch the system on and off.

## Deactivating the rear view camera

**Note:** The display will stay on for a short period before switching off.

Disengage reverse gear.

# Cruise control

## PRINCIPLE OF OPERATION

Cruise control allows you to control your speed using the switches on the steering wheel. You can use cruise control when you exceed approximately 30 km/h (20 mph).

## USING CRUISE CONTROL

### WARNING



Do not use cruise control in heavy traffic, on twisty roads or when the road surface is slippery.

## Switching cruise control on



E102679

**Note:** The system is ready for you to set a speed.

## Setting a speed

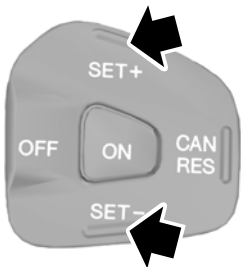

E102680

Press to store and maintain your current speed. The cruise control indicator will illuminate. See **Warning lamps and indicators** (page 59).

## Changing the set speed

### WARNING



When you are going downhill, your speed may increase above the set speed. The system will not apply the brakes. Change down a gear and press the **SET-** switch to assist the system in maintaining the set speed.

**Note:** If you accelerate by pressing the accelerator pedal, the set speed will not change. When you release the accelerator pedal, you will return to the speed that you previously set.

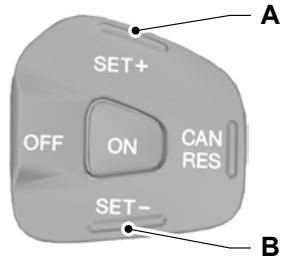

E102681

- A Accelerate
- B Decelerate

# Cruise control

## Cancelling the set speed

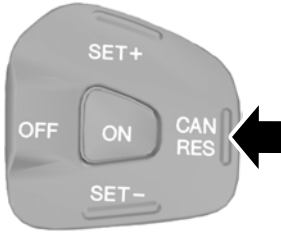

E102682

Press the brake pedal or the **CAN RES** switch.

**Note:** *The system will no longer control your speed. The cruise control indicator will not illuminate but the system will retain the speed that you previously set.*

## Switching cruise control off

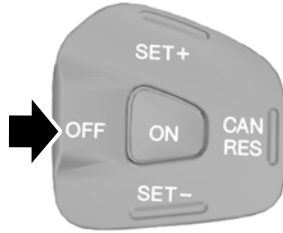

E102683

The system will not retain the speed that you previously set. The cruise control indicator will not illuminate.

## Resuming the set speed

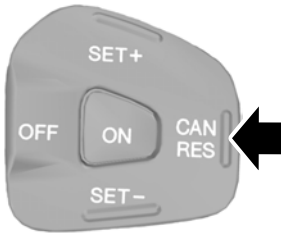





E102682

The cruise control indicator will illuminate and the system will attempt to resume the speed that you previously set.



# Load carrying

## GENERAL INFORMATION

### WARNINGS

-  Use load securing straps to an approved standard, e.g. DIN.
-  Make sure that you secure all loose items properly.
-  Place luggage and other loads as low and as far forward as possible within the luggage or loadspace.
-  Do not drive with the tailgate or rear door open. Exhaust fumes may enter the vehicle.
-  Do not exceed the maximum front and rear axle loads for your vehicle. See **Vehicle identification** (page 154).

### CAUTIONS

-  Do not allow items to contact the rear windows.
-  Do not use any abrasive materials to clean the interior of the rear windows.
-  Do not install stickers or labels to the interior of the rear windows.

## LUGGAGE COVERS

### CAUTION

-  Do not place objects on the luggage cover.

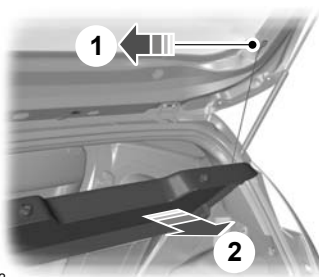



E72512

## ROOF RACKS AND LOAD CARRIERS

### Roof rack

#### WARNINGS

-  If you use a roof rack, the fuel consumption of your vehicle will be higher and you may experience different driving characteristics.
-  Read and follow the manufacturer's instructions when you are fitting a roof rack.

#### CAUTION

-  Do not exceed the maximum permissible roof load of 50 kilogrammes (110 pounds) (including the roof rack).

Check the security of the roof rack and tighten its fittings as follows:

- before starting
- after driving 50 kilometres (30 miles)
- at 1 000 kilometres (600 miles) intervals or less, depending on road surface.

To reduce fuel consumption, cross rails should be removed when not in use.

# Towing

## TOWING A TRAILER

### WARNINGS



Do not exceed 100 km/h (62 mph).



The rear tyre pressures must be increased by 0.2 bar (3 psi) above specification. See **Technical specifications** (page 150).



Do not exceed the maximum gross train weight stated on the vehicle identification plate. See **Vehicle identification plate** (page 154).



ECONetic vehicles are not approved for trailer towing.

### CAUTIONS



Do not exceed the maximum permissible nose weight, i.e. vertical weight on the tow ball, of 50 kilogrammes (110 pounds).



The electrical system is not suitable for towing trailers with more than one rear fog lamp.

**Note:** *Not all vehicles are suitable or approved to have tow bars fitted. Check with your dealer first.*

Place loads as low and central to the axle(s) of the trailer as possible. If you are towing with an unladen vehicle, the load in the trailer should be placed toward the nose, within the maximum nose load, as this gives the best stability.

The stability of the vehicle to trailer combination is very much dependant on the quality of the trailer.

In high altitude regions above 1 000 metres (3 281 feet), the stipulated maximum permitted gross train weight must be reduced by 10% for every additional 1 000 metres (3 281 feet).

## Steep gradients

### WARNING



The overrun brake on a trailer is not controlled by ABS.

Change down a gear before you reach a steep downhill gradient.

## DETACHABLE TOW BALL

### WARNINGS



When not in use, always transport the tow ball arm securely fastened in the luggage compartment.



Take special care when fitting the tow ball arm as the safety of the vehicle and the trailer depends on this.



Do not use any tools for mounting or dismounting the tow ball arm. Do not modify the trailer coupling. Do not disassemble or repair the tow ball arm.

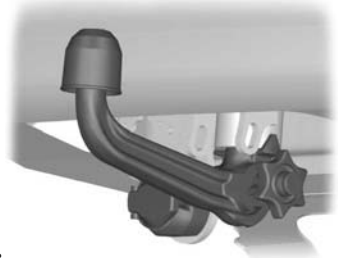

E71328

A 13-pin trailer socket and the tow ball arm seat are provided underneath the rear bumper. Turn the trailer socket down through 90 degrees until it engages in the end position.

# Towing

## Unlocking the tow ball arm mechanism

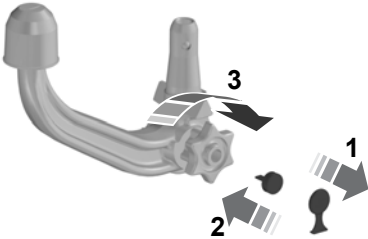

E71329

1. Remove the protecting cap (1). Insert the key and turn it clockwise to unlock (2).
2. Hold the tow ball arm. Pull the handwheel out and turn it clockwise until it clicks (3).
3. The red mark on the handwheel must align with the green mark on the tow ball.
4. Release the handwheel. The tow ball arm is unlocked.

## Inserting the tow ball arm

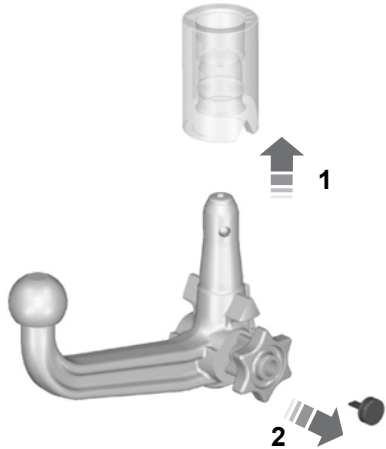

E71330

### WARNING



The tow ball arm may only be inserted when completely unlocked.

1. Pull out the plug.
2. Insert the tow ball arm vertically and press it upwards until it engages (1). Do not hold your hand near the handwheel.
3. The green mark on the handwheel must align with the green mark on the tow ball.
4. To lock, turn the key anti-clockwise and remove the key (2).
5. Pull the protecting cap from the key bow and press it onto the lock.

# Towing

## Driving with a trailer

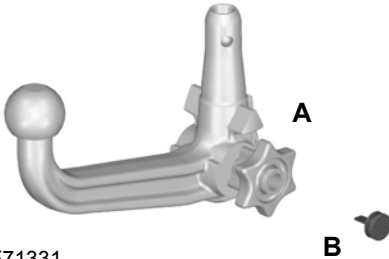

E71331

### WARNING



If any of the below conditions cannot be met, do not use the tow bar and have it checked by a properly trained technician.

Before starting your journey, make sure that the tow ball arm is properly locked. Check:

- the green marks are aligned.
- the handwheel (**A**) is correctly fitted to the tow ball arm.
- you have removed the key (**B**).
- the tow ball arm is securely positioned. It must not move when jerked.

## Removing the tow ball arm

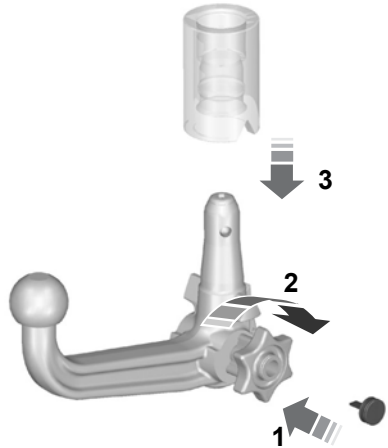

E71332

1. Unhitch the trailer.
2. Remove the protecting cap. Press the cap into the key bow. Insert the key and unlock (**1**).
3. Hold the tow ball arm. Pull the handwheel out, turn it clockwise against the stop (**2**) and remove the tow ball arm (**3**).
4. Release the handwheel.

When unlocked in this way, the tow ball arm can be reinserted at any time.

# Towing

---

## Driving without a trailer

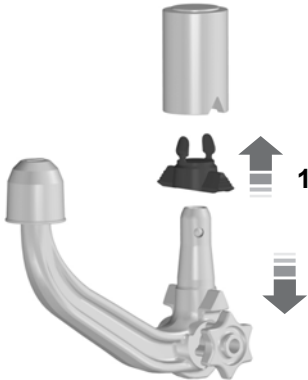

E94771

1. Remove the tow ball arm.
2. Insert the plug into its seat (1).

### WARNING



Never unlock the tow ball arm with the trailer attached.

---

## Maintenance

### CAUTION



Remove the tow ball arm and protect the seat with the plug before steam cleaning your vehicle.

---

Keep the system clean. Periodically lubricate bearings, sliding surfaces, and locking balls with resin-free grease or oil and the lock with graphite.

Keep a note of the key number. In case of loss, replacement keys are available from the manufacturer by stating the 4-digit key number.

# Driving hints

---

## RUNNING-IN

### Tyres

#### WARNING



New tyres need to be run-in for approximately 500 kilometres (300 miles). During this time, you may experience different driving characteristics.

---

### Brakes and clutch

#### WARNING



Avoid heavy use of the brakes and clutch if possible for the first 150 kilometres (100 miles) in town and for the first 1 500 kilometres (1 000 miles) on motorways.

---

### Engine

#### CAUTION



Avoid driving too fast during the first 1 500 kilometres (1 000 miles). Vary your speed frequently and change up through the gears early. Do not labour the engine.

---

## COLD WEATHER PRECAUTIONS

The functional operation of some components and systems can be affected at temperatures below  $-30^{\circ}\text{C}$  ( $-22^{\circ}\text{F}$ ).

## DRIVING THROUGH WATER

### Driving through water

#### CAUTIONS



Drive through water in an emergency only, and not as part of normal driving.



Engine damage can occur if water enters the air filter.

---

In an emergency, the vehicle can be driven through water to a maximum depth of 200 mm and at a maximum speed of 10 km/h (6 mph). Extra caution should be exercised when driving through flowing water.

When driving in water, maintain a low speed and do not stop the vehicle. After driving through water, and as soon as it is safe to do so:

- Depress the brake pedal lightly and check that full brake function is achieved.
- Check that the horn works.
- Check that the vehicle's lights are fully operational.
- Check the power assistance of the steering system.

# Emergency equipment

---

## **FIRST AID KIT**

Space is provided in the spare wheel well.

## **WARNING TRIANGLE**

Space is provided in the spare wheel well.

# Fuses

## FUSE BOX LOCATIONS

### Engine compartment fuse box

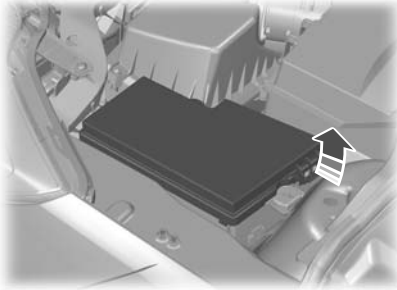

E78332

### Passenger compartment fuse box

This fuse box is located behind the glove box. Open the glove box and empty the contents. Press the sides inwards and swivel the glove box downwards.

## CHANGING A FUSE

### WARNINGS

 Do not modify the electrical system of your vehicle in any way. Have repairs to the electrical system and the replacement of relays and high current fuses carried out by properly trained technicians.

 Switch the ignition and all electrical equipment off before touching or attempting to change a fuse.

### CAUTION

 Fit a replacement fuse with the same rating as the one you have removed.

**Note:** *You can identify a blown fuse by a break in the filament.*

**Note:** *All fuses, except high current fuses, are a push fit.*

# Fuses

## FUSE SPECIFICATION CHART

### Engine compartment fuse box

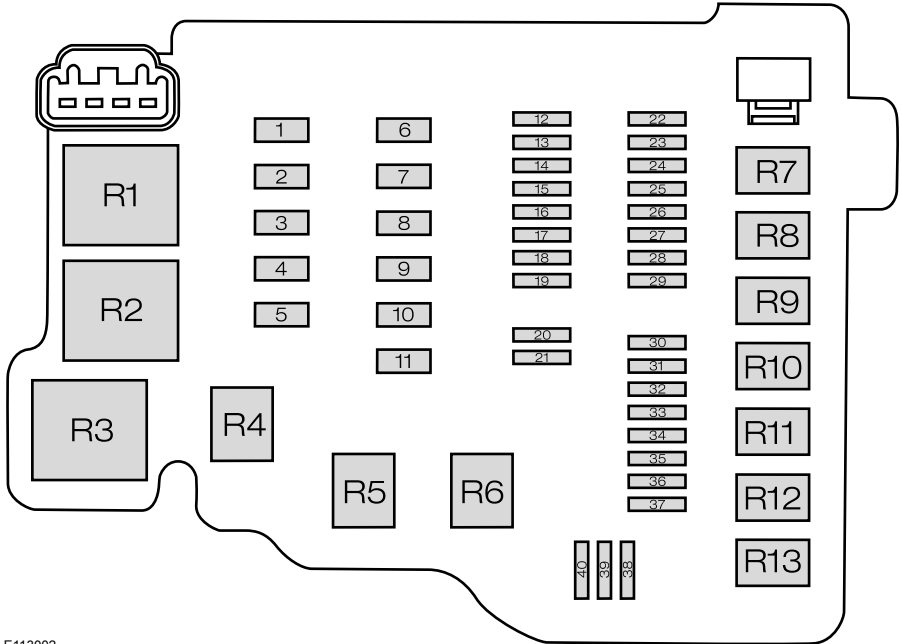

E113002

Fuse	Ampere rating	Circuits protected
1	40	ABS module
1	30	ABS ESP module
2	60	Cooling system fan high speed
3	40	Cooling system fan
3	30	Cooling system fan low speed
4	30	Heater blower
5	60	Passenger compartment fuse box supply (battery)

## Fuses

Fuse	Ampere rating	Circuits protected
6	30	Body control module (BCM)
7	60	Passenger compartment fuse box supply (ignition)
8	60	Glow plugs
9	60	Heated windscreen
10	-	Not used
11	30	Starter relay
12	10	Main beam left-hand relay
13	10	Main beam right-hand relay
14	10	Dipped beam left-hand relay
15	10	Dipped beam right-hand relay
16	15	Powertrain control module (PCM), high and low cooling fan
17	15	Heated oxygen (HEGO) sensors (Petrol engines)
17	20	Power supply module (Diesel engines)
18	10	FN (Automatic) transmission
19	-	Not used
20	-	Not used
21	-	Not used
22	15	Lighting control battery supply
23	15	Front fog lamps
24	15	Direction indicators
25	10	Daytime running lamps
26	7.5	Electric exterior mirrors switch, electric folding mirrors, power window (driver's door)
27	7.5	PCM
28	20	ABS module, ESP
29	10	Air conditioning clutch

## Fuses

Fuse	Ampere rating	Circuits protected
30	-	Not used
31	-	Not used
32	20	Horn, battery saver, keyless vehicle module
33	20	Heated rear window
34	20	Fuel pump relay, diesel fuel heater
35	-	Not used
36	-	Not used
37	-	Not used
38	-	Not used
39	-	Not used
40	-	Not used

Relay	Circuits switched
R1	Cooling system fan
R2	Glow plugs (DV4 Stage 4 only), Heated windscreen
R3	PCM
R4	Main beam
R5	Dipped beam
R6	Daytime running lamps
R7	Engine cooling fan
R8	Starter
R9	Air conditioning clutch
R10	Front fog lamps
R11	Fuel pump, fuel heater
R12	Reverse lamp
R13	Heater blower

# Fuses

## Passenger compartment fuse box - Type 1

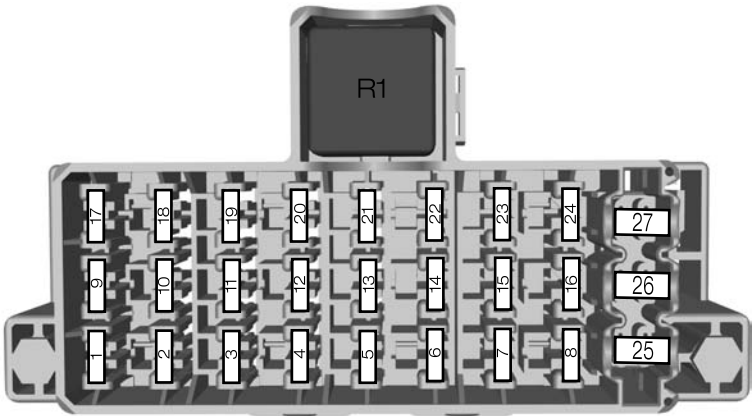

E125747

Fuse	Ampere rating	Circuits protected
1	7.5	Ignition, rain sensor, heated windscreen
2	10	Stop lamps
3	7.5	Reversing lamp, Rear view camera (VP)
4	7.5	Headlamp levelling
5	20	Windscreen wipers
6	15	Rear window wiper
7	15	Washer pump
8	10	Parking aid (vehicles with front parking aid)
9	-	Not used
10	7.5	Heated seats
11	-	Not used
12	10	Airbag module

## Fuses

Fuse	Ampere rating	Circuits protected
13	10	Ignition, electric power assisted steering (EPAS), instrument cluster, passive anti theft system (PATS), ABS
14	7.5	PCM, gear selector lever, fuel pump,
15	7.5	Audio system, instrument cluster
16	7.5	Heated exterior mirror
17	15	Ignition switch
18	7.5	Instrument Cluster
19	15	Data link connector
20	7.5	Multi functional display, clock, internal scanner, heating ventilating, air conditioning (HVAC) panel
21	15	Audio system, Bluetooth
22	20	Cigar lighter, front power point
23	20	Trailer module
24	-	Not used
25	30	Power windows (front)
26	30	Heated windscreen, left-hand side
27	30	Heated windscreen, right-hand side

Relay	Circuits switched
R1	Ignition

# Fuses

## Passenger compartment fuse box - Type 2

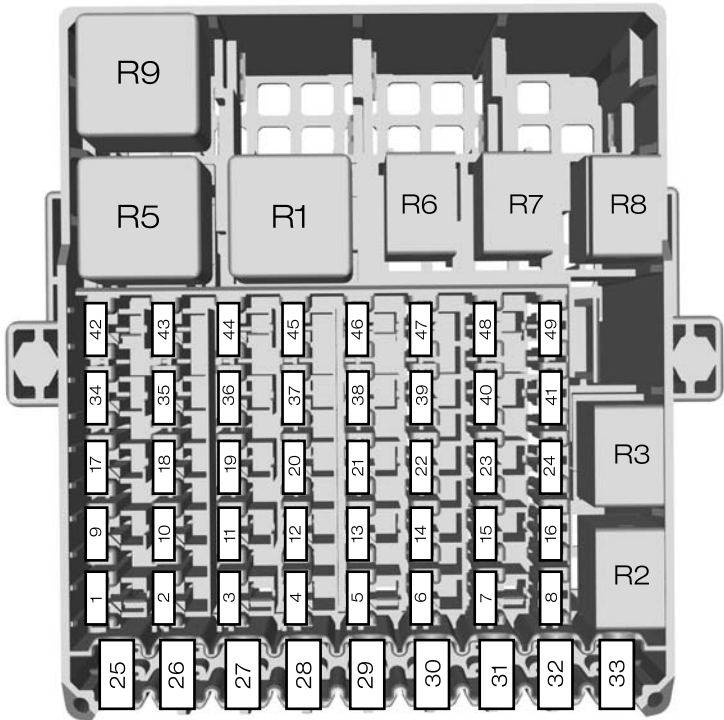

E125748

Fuse	Ampere rating	Circuits protected
1	7.5	Ignition, rain sensor, heated front screen
2	10	Stop lamps
3	7.5	Reversing lamp
4	7.5	Headlamp levelling
5	20	Windscreen wipers
6	15	Rear window wiper

## Fuses

<b>Fuse</b>	<b>Ampere rating</b>	<b>Circuits protected</b>
7	15	Washer pump
8	10	Parking aid (vehicles with front parking aid)
9	-	Not used
10	7.5	Heated seats
11	-	Not used
12	10	Airbag module
13	10	Ignition, electric power assisted steering (EPAS), instrument cluster, passive anti theft system (PATS), ABS
14	7.5	PCM, gear selector lever, fuel pump,
15	7.5	Audio system, instrument cluster
16	7.5	Heated exterior mirror
17	15	Ignition switch
18	7.5	Instrument cluster
19	15	Data link connector
20	7.5	Multi functional display, clock, internal scanner, HVAC panel
21	15	Audio system, Bluetooth
22	-	Not used
23	20	Trailer module
24	-	Not used
25	30	Power windows (front)
26	30	Heated windscreen, left-hand side

# Fuses

Fuse	Ampere rating	Circuits protected
27	30	Heated windscreen, right-hand side
28	-	Not used
29	-	Not used
30	20	Cigar lighter, Front power point
31	30	Power windows (rear)
32	-	Not used
33	-	Not used
34	20	Keyless entry
35	20	Keyless entry
36	-	Not used
37	-	Not used
38	-	Not used
39	-	Not used
40	-	Not used
41	-	Not used
42	-	Not used
43	-	Not used
44	-	Not used
45	-	Not used
46	-	Not used
47	-	Not used
48	-	Not used
49	-	Not used

Relay	Circuits switched
R1	Ignition

## Fuses

---

<b>Relay</b>	<b>Circuits switched</b>
R2	Power fold mirror 1
R3	Power fold mirror 2
R4	Not used
R5	Not used
R6	Keyless entry (accessory)
R7	Keyless entry (ignition)
R8	Not used
R9	Not used
R10	Not used
R11	Not used
R12	Not used

# Vehicle recovery

## TOWING POINTS

### Front towing eye

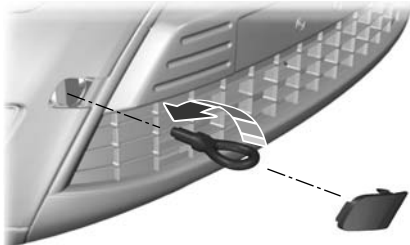

E99490

Space is provided in the spare wheel well.

The towing eye must **always** be carried in the vehicle.

Prise off the cover and install the towing eye.

#### CAUTION

! The screw-in towing eye has a **left-hand thread**. Turn it **anti-clockwise** to install it. Make sure that the towing eye is fully tightened.

### Rear towing hook

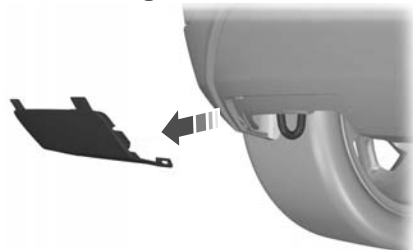

E102895

Prise off the cover.

**Note:** *On vehicles with a tow bar, use the tow bar to tow a vehicle.*

## TOWING THE VEHICLE ON FOUR WHEELS

### All vehicles

#### WARNINGS

- ! Switch the ignition on when your vehicle is being towed. The steering lock will engage and the direction indicators and brake lamps will not work if you do not.
- ! The brake and steering assistance will not operate unless the engine is running. Press the brake pedal harder and allow for increased stopping distances and heavier steering.

#### CAUTIONS

- ! Too much tension in the tow rope could cause damage to your vehicle or the vehicle that is towing.
- ! Do not use a rigid tow bar on the front towing eye.
- ! Select neutral when your vehicle is being towed.

Drive off slowly and smoothly without jerking the vehicle that is towing.

### Vehicles with automatic transmission



#### CAUTIONS

- ! If a speed of 20 km/h (12 mph) and a distance of 20 kilometres (12 miles) is to be exceeded the drive wheels must be lifted clear of the ground.
- ! It is recommended not to tow with the drive wheels on the ground. However, if it is required to move the vehicle from a dangerous location, do not tow your vehicle faster than 20 km/h (12 mph) or further than 20 kilometres (12 miles).

# Vehicle recovery

---

## CAUTIONS

-  Do not tow your vehicle backwards.
  -  In the event of a mechanical failure of the transmission the drive wheels must be lifted clear of the ground.
  -  Do not tow your vehicle if the ambient temperature is below 0°C (32°F).
-

# Maintenance

---

## GENERAL INFORMATION

Have your vehicle serviced regularly to help maintain its roadworthiness and resale value. There is a large network of Ford Authorised Repairers that are there to help you with their professional servicing expertise. We believe that their specially trained technicians are best qualified to service your vehicle properly and expertly. They are supported by a wide range of highly specialised tools developed specifically for servicing your vehicle.

In addition to regular servicing, we recommend that you carry out the following additional checks.

### WARNINGS



Switch the ignition off before touching or attempting adjustment of any kind.



Do not touch the electronic ignition system parts after you have switched the ignition on or when the engine is running. The system operates at high voltage.



Keep your hands and clothing clear of the engine cooling fan. Under certain conditions, the fan may continue to run for several minutes after you have switched the engine off.

### CAUTION



When carrying out maintenance checks, make sure that filler caps are fitted securely.

## Daily checks

- Exterior lamps.
- Interior lamps.
- Warning lamps and indicators.

## Check when refuelling

- Engine oil level. See **Engine oil check** (page 133).
- Brake fluid level. See **Brake and clutch fluid check** (page 134).
- Washer fluid level. See **Washer fluid check** (page 134).
- Tyre pressures (when cold). See **Technical specifications** (page 150).
- Tyre condition. See **Wheels and tyres** (page 141).

## Monthly checks

- Engine coolant level (engine cold). See **Engine coolant check** (page 133).
- Pipes, hoses and reservoirs for leaks.
- Air conditioning operation.
- Parking brake operation.
- Horn operation.
- Tightness of wheel nuts. See **Technical specifications** (page 150).

# Maintenance

## OPENING AND CLOSING THE BONNET

### Opening the bonnet



E102165

For item location: See **Quick start** (page 10).

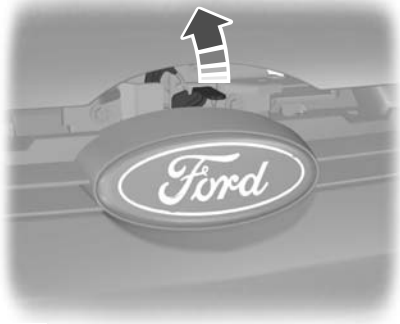

E102884

Raise the bonnet slightly and move the catch towards the left-hand side of the vehicle.

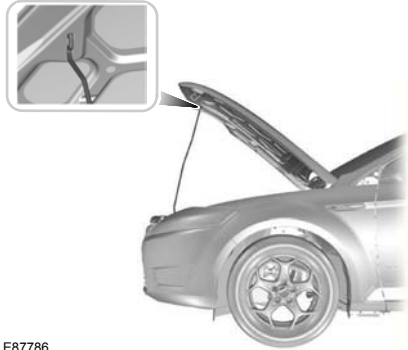

E87786

Open the bonnet and support it with the strut.

### Closing the bonnet

#### WARNING



Make sure that the bonnet is closed properly.

Lower the bonnet and allow it to drop from under its own weight for the last 20 – 30 centimetres (8 - 11 inches).

# Maintenance

## ENGINE COMPARTMENT OVERVIEW - 1.25L DURATEC-16V (SIGMA)/1.4L DURATEC-16V (SIGMA)/1.6L DURATEC-16V TI-VCT (SIGMA)

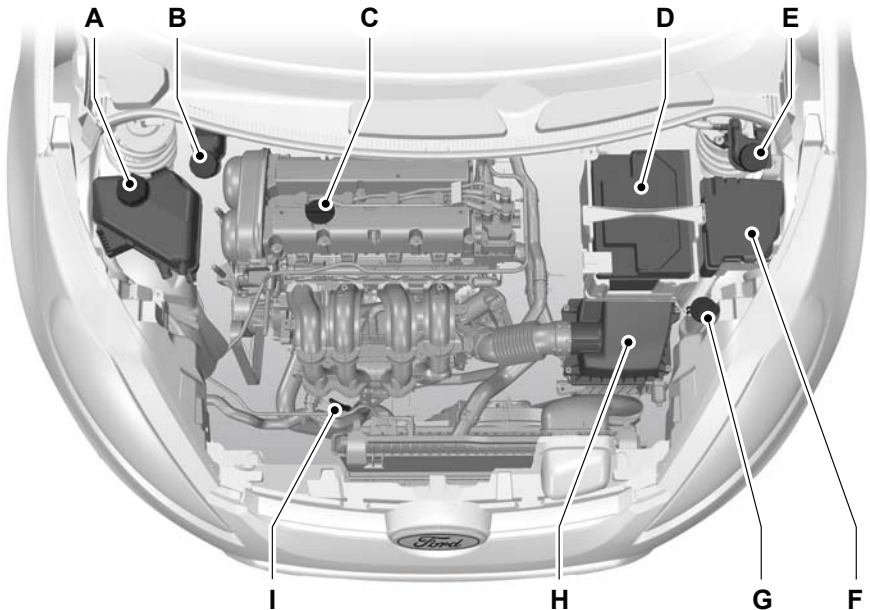

E103505

- A Engine coolant reservoir\*: See **Engine coolant check** (page 133).
- B Brake and clutch fluid reservoir (right-hand drive)\*: See **Brake and clutch fluid check** (page 134).
- C Engine oil filler cap\*: See **Engine oil check** (page 133).
- D Battery: See **Vehicle battery** (page 139).
- E Brake and clutch fluid reservoir (left-hand drive)\*: See **Brake and clutch fluid check** (page 134).
- F Engine compartment fuse box. See **Fuses** (page 115).
- G Windscreen and rear window washer fluid reservoir: See **Washer fluid check** (page 134).

# Maintenance

H Air cleaner: No maintenance necessary.

I Engine oil dipstick\*: See **Engine oil check** (page 133).

\* The filler caps and the engine oil dipstick are coloured for easy identification.

## ENGINE COMPARTMENT OVERVIEW - 1.4L DURATORQ-TDCI (DV) DIESEL

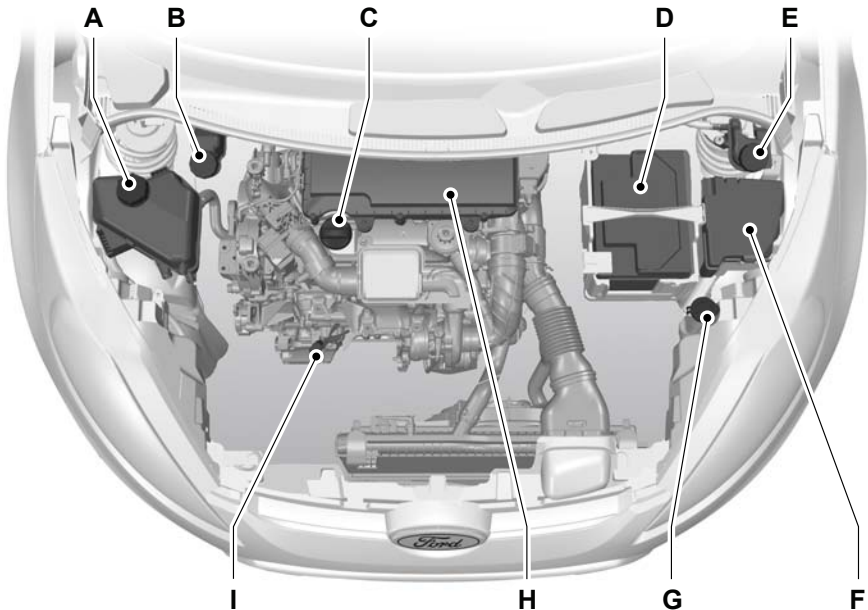

E103508

A Engine coolant reservoir\*: See **Engine coolant check** (page 133).

B Brake and clutch fluid reservoir (right-hand drive)\*: See **Brake and clutch fluid check** (page 134).

C Engine oil filler cap\*: See **Engine oil check** (page 133).

D Battery: See **Vehicle battery** (page 139).

# Maintenance

- E Brake and clutch fluid reservoir (left-hand drive)\*: See **Brake and clutch fluid check** (page 134).
- F Engine compartment fuse box. See **Fuses** (page 115).
- G Windscreen and rear window washer fluid reservoir: See **Washer fluid check** (page 134).
- H Air cleaner: No maintenance necessary.
- I Engine oil dipstick\*: See **Engine oil check** (page 133).

\* The filler caps and the engine oil dipstick are coloured for easy identification.

## ENGINE COMPARTMENT OVERVIEW - 1.6L DURATORQ-TDCI (DV) DIESEL

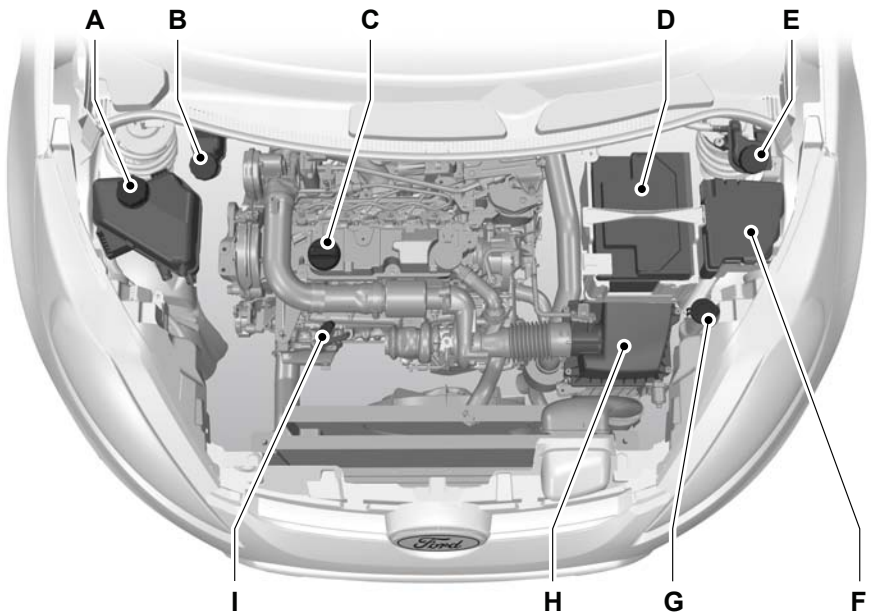

E103509

# Maintenance

- A Engine coolant reservoir\*: See **Engine coolant check** (page 133).
- B Brake and clutch fluid reservoir (right-hand drive)\*: See **Brake and clutch fluid check** (page 134).
- C Engine oil filler cap\*: See **Engine oil check** (page 133).
- D Battery: See **Vehicle battery** (page 139).
- E Brake and clutch fluid reservoir (left-hand drive)\*: See **Brake and clutch fluid check** (page 134).
- F Engine compartment fuse box. See **Fuses** (page 115).
- G Windscreen and rear window washer fluid reservoir: See **Washer fluid check** (page 134).
- H Air cleaner: No maintenance necessary.
- I Engine oil dipstick\*: See **Engine oil check** (page 133).

\* The filler caps and the engine oil dipstick are coloured for easy identification.

## ENGINE OIL DIPSTICK - 1.25L DURATEC-16V (SIGMA)/1.4L DURATEC-16V (SIGMA)/1.6L DURATEC-16V TI-VCT (SIGMA)

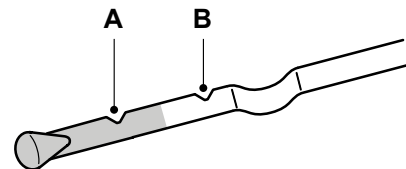

E95540

- A MIN
- B MAX

## ENGINE OIL DIPSTICK - 1.4L DURATORQ-TDCI (DV) DIESEL/1.6L DURATORQ- TDCI (DV) DIESEL

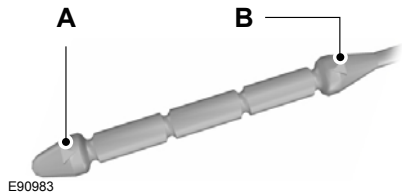

E90983

- A MIN
- B MAX

# Maintenance

## ENGINE OIL CHECK

### CAUTION

 Do not use oil additives or other engine treatments. Under certain conditions, they could damage the engine.

**Note:** *The oil consumption of new engines reaches its normal level after approximately 5 000 kilometres (3 000 miles).*

### Checking the oil level

### CAUTION

 Make sure that the level is between the **MIN** and the **MAX** marks.

**Note:** *Check the level before starting the engine.*

**Note:** *Make sure that your vehicle is on level ground.*

**Note:** *Oil expands when it is hot. The level may therefore extend a few millimetres beyond the **MAX** mark.*

Remove the dipstick and wipe it with a clean, lint free cloth. Replace the dipstick and remove it again to check the oil level.

If the level is at the **MIN** mark, top up immediately.

### Topping up

### WARNINGS

 Only top up when the engine is cold. If the engine is hot, wait 10 minutes for the engine to cool down.

 Do not remove the filler cap when the engine is running.

Remove the filler cap.

### CAUTION

 Do not top up further than the **MAX** mark.

Top up with fluid that meets the Ford specification. See **Technical specifications** (page 135).

Replace the filler cap. Turn it until you feel a strong resistance.

## ENGINE COOLANT CHECK

### Checking the coolant level

### WARNING

 Do not allow the fluid to touch your skin or eyes. If this happens, rinse the affected areas immediately with plenty of water and contact your doctor.

### CAUTION

 Make sure that the level is between the **MIN** and the **MAX** marks.

**Note:** *Coolant expands when it is hot. The level may therefore extend beyond the **MAX** mark.*

If the level is at the **MIN** mark, top up immediately.

### Topping up

### WARNINGS

 Only top up when the engine is cold. If the engine is hot, wait 10 minutes for the engine to cool down.

 Do not remove the filler cap when the engine is running.

 Do not remove the filler cap when the engine is hot. Wait for the engine to cool down.

# Maintenance

---

## WARNINGS



Undiluted coolant is flammable and may ignite if spilt on a hot exhaust.

## CAUTIONS



In an emergency, you can add just water to the cooling system to reach a vehicle service station. Have the system checked by a properly trained technician as soon as possible.



Prolonged use of incorrect dilution of the coolant can cause engine damage from corrosion, overheating or freezing.

Unscrew the cap **slowly**. Any pressure will escape slowly as you unscrew the cap.

## CAUTION



Do not top up further than the **MAX** mark.

Top up with a 50/50 mixture of coolant and water using fluid that meets the Ford specification. See **Technical specifications** (page 135).

## WASHER FLUID CHECK

**Note:** *The front and rear washer systems are supplied from the same reservoir.*

When topping up, use a mixture of washer fluid and water to help prevent freezing in cold weather and improve the cleaning capability. We recommend that you use only high quality washer fluid.

For information on fluid dilution, refer to the product instructions.

## BRAKE AND CLUTCH FLUID CHECK

### WARNINGS



Do not allow the fluid to touch your skin or eyes. If this happens, rinse the affected areas immediately with plenty of water and contact your doctor.



If the level is at the **MIN** mark, have the system checked by a properly trained technician as soon as possible.

**Note:** *Contamination with dirt, water, petroleum products or other materials may result in brake failure or costly repairs.*

**Note:** *The brake and the clutch systems are supplied from the same reservoir.*

Top up with fluid that meets the Ford specification. See **Technical specifications** (page 135).

# Maintenance

## TECHNICAL SPECIFICATIONS

### Vehicle fluids

Item	Recommended fluid	Specification
Engine oil.	Castrol Engine Oil <sup>*</sup>	WSS-M2C913-C
Coolant	Motorcraft SuperPlus Anti-freeze	WSS-M97B44-D
Brake fluid	Shell ESL DOT4 brake fluid	WSS-M6C57-A2

<sup>\*</sup> Providing it meets the specification defined by **WSS-M2C913-C**, you can also use Ford Engine Oil or an alternative engine oil.

**Note:** If you operate your vehicle in temperatures below  $-20^{\circ}\text{C}$  ( $-4^{\circ}\text{F}$ ), you must not use **SAE 10W-40** engine oil.

**Topping up the oil:** If you are unable to find an oil that meets the specification defined by **WSS-M2C913-C**, you must use **SAE 5W-30** (preferred), **SAE 5W-40** (except vehicles with E85 fuel) or **SAE 10W-40** that meets the specification defined by either **ACEA A5/B5** (preferred) or **ACEA A3/B3**. Using these oils can result in longer engine cranking periods, reduced engine performance, reduced fuel economy and increased emission levels.

Shell ESL DOT4 brake fluid recommended.

Castrol engine oil recommended.



### Capacities

Variant	Item	Capacity in litres (gallons)
All	Windscreen and rear window washer system	2.5 (0.6)
Vehicles with a petrol engine	Engine cooling system	approx. 5.5 (1.2)
Vehicles with a diesel engine	Engine cooling system	approx. 6.1 (1.3)
Vehicles with a petrol engine	Fuel tank	42 (9.2)

# Maintenance

<b>Variant</b>	<b>Item</b>	<b>Capacity in litres (gallons)</b>
Vehicles with a diesel engine	Fuel tank	40 (8.8)
1.25L Duratec-16V (Sigma)/1.4L Duratec-16V (Sigma)	Engine lubrication system - including the oil filter	3.8 (0.8)
1.25L Duratec-16V (Sigma)/1.4L Duratec-16V (Sigma)	Engine lubrication system - excluding the oil filter	3.5 (0.8)
1.6L Duratec-16V Ti-VCT (Sigma)	Engine lubrication system - including the oil filter	4 (0.9)
1.6L Duratec-16V Ti-VCT (Sigma)	Engine lubrication system - excluding the oil filter	3.8 (0.8)
1.4L Duratorq-TDCi (DV) Diesel	Engine lubrication system - including the oil filter	3.8 (0.8)
1.4L Duratorq-TDCi (DV) Diesel	Engine lubrication system - excluding the oil filter	3.4 (0.7)
1.6L Duratorq-TDCi (DV) Diesel	Engine lubrication system - including the oil filter	3.9 (0.9)
1.6L Duratorq-TDCi (DV) Diesel	Engine lubrication system - excluding the oil filter	3.5 (0.8)

## Engine oil top up capacities

<b>Engine</b>	<b>Capacity in litres (gallons)</b>
1.25L Duratec-16V (Sigma)/1.4L Duratec-16V (Sigma)/1.6L Duratec-16V Ti-VCT (Sigma)	0.8 (0.2)
1.4L Duratorq-TDCi (DV) Diesel/1.6L Duratorq-TDCi (DV) Diesel	1.6 (0.4)

# Vehicle care

---

## CLEANING THE EXTERIOR

### WARNING



If you use a car wash with a waxing cycle, make sure that you remove the wax from the windscreen.

---

### CAUTIONS



Prior to using a car wash facility check the suitability of it for your vehicle.



Some car wash installations use water at high pressure. This could damage certain parts of your vehicle.



Remove the aerial before using an automatic car wash.



Switch the heater blower off to prevent contamination of the fresh air filter.

---

We recommend that you wash your vehicle with a sponge and lukewarm water containing a car shampoo.

## Cleaning the headlamps

### CAUTIONS



Do not scrape the headlamp lenses or use abrasives, alcoholic solvents or chemical solvents to clean them.



Do not wipe the headlamps when they are dry.

---

## Cleaning the rear window

### CAUTION



Do not scrape the inside of the rear window or use abrasives or chemical solvents to clean it.

---

Use a clean, lint free cloth or a damp chamois leather to clean the inside of the rear window.

## Cleaning the chrome trim

### CAUTION



Do not use abrasives or chemical solvents. Use soapy water.

---

## Body paintwork preservation

### CAUTIONS



Do not polish your vehicle in strong sunshine.



Do not allow polish to touch plastic surfaces. It could be difficult to remove.



Do not apply polish to the windscreen or rear window. This could cause the wipers to become noisy and they may not clear the window properly.

---

We recommend that you wax the paintwork once or twice a year.

## CLEANING THE INTERIOR

### Seat belts

### WARNINGS



Do not use abrasives, or chemical solvents to clean them.



Do not allow moisture to penetrate the seat belt retractor mechanism.

---

Clean the seat belts with interior cleaner or water applied with a soft sponge. Let the seat belts dry naturally, away from artificial heat.

## **Instrument cluster screens, LCD screens, radio screens**

### **WARNING**



Do not use abrasives, alcoholic solvents or chemical solvents to clean them.

---

## **REPAIRING MINOR PAINT DAMAGE**

### **CAUTION**



Remove apparently harmless looking substances from the paintwork immediately (e.g. bird droppings, tree resins, insect remains, tar spots, road salt and industrial fall out).

---

You should repair paintwork damage caused by stones from the road or minor scratches as soon as possible. A choice of products is available from your Ford Dealer. Read and follow the manufacturer's instructions.

# Vehicle battery

## USING BOOSTER CABLES

### CAUTIONS

- ⚠ Connect batteries with only the same nominal voltage.
- ⚠ Always use booster cables with insulated clamps and adequate size cable.
- ⚠ Do not disconnect the battery from the vehicle's electrical system.

### To connect the booster cables

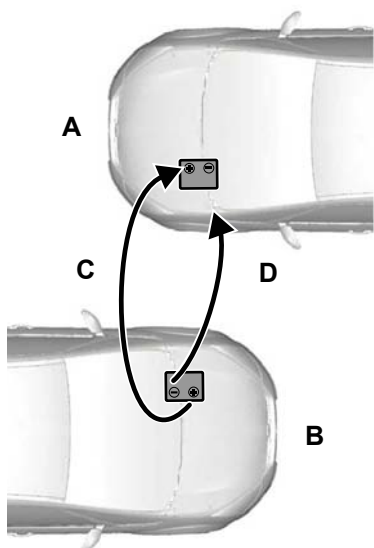

E102925

- A Flat battery vehicle
- B Booster battery vehicle
- C Positive connection cable
- D Negative connection cable

1. Position the vehicles so that they do not touch one another.
2. Switch off the engine and any electrical equipment.
3. Connect the positive (+) terminal of vehicle **B** with the positive (+) terminal of vehicle **A** (cable **C**).
4. Connect the negative (-) terminal of vehicle **B** to the ground connection of vehicle **A** (cable **D**). See **Battery connection points** (page 140).

### CAUTIONS

- ⚠ **Do not connect to the negative (-) terminal of the flat battery.**
- ⚠ Make sure that the cables are clear of any moving parts.

### To start the engine

1. Run the engine of vehicle **B** at moderately high speed.
2. Start the engine of vehicle **A**.
3. Run both vehicles for a minimum of three minutes before disconnecting the cables.

### CAUTION

- ⚠ Do not switch on the headlamps when disconnecting the cables. The peak voltage could blow the bulbs.

Disconnect the cables in the reverse order.

# Vehicle battery

---

## BATTERY CONNECTION POINTS



E102923

### CAUTION

**!** Do not connect to the negative (-) terminal of the flat battery.

# Wheels and tyres

## GENERAL INFORMATION

### CAUTIONS

 Use only approved wheel and tyre sizes. Using other sizes could damage the vehicle and will make the National Type Approval invalid.

 If you change the diameter of the tyres from that fitted at the factory, the speedometer may not display the correct speed. Take the vehicle to your dealer to have the engine management system reprogrammed.

A decal with tyre pressure data is located in the left-hand door opening at the B-pillar.

Check and set the tyre pressure at the ambient temperature in which you are intending to drive the vehicle and when the tyres are cold.

## CHANGING A ROAD WHEEL

### Locking wheel nuts

You can obtain a replacement locking wheel nut key and replacement locking wheel nuts from your dealer using the reference number certificate.

### Vehicles with a temporary spare wheel

#### WARNINGS

 If the spare wheel differs from the other fitted wheels, these rules must be followed:

 Do not exceed 80 km/h (50 mph).

 Drive the shortest possible distances.

#### WARNINGS

 Do not fit more than one spare wheel on your vehicle at any one time.

**Note:** *Your vehicle may exhibit some unusual driving characteristics.*

### Vehicle jack

#### WARNINGS

 The vehicle jack supplied with your vehicle should only be used when changing a wheel in emergency situations.

 Before using the vehicle jack, check that it is not damaged or deformed and that the thread is lubricated and free from foreign matter.

 Never place anything between the jack and the ground, or the jack and the vehicle.

**Note:** *Vehicles with a tyre repair kit are not equipped with a vehicle jack or a wheel brace.*

It is recommended to use a workshop type hydraulic jack for changing between summer and winter tyres.

**Note:** *Use a jack with a minimum lifting capacity of one tonne (one ton) and a lifting plate with a minimum diameter of 80 millimetres (3.1 inches).*

Your vehicle jack, wheel brace, screw-in towing eye and wheel trim remover are located in the spare wheel well.

# Wheels and tyres

## Jacking and lifting points

### CAUTION

! Use only the specified jacking points. If you use other positions, you may damage the body, steering, suspension, engine, braking system or the fuel lines.

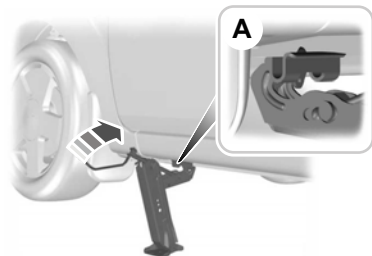
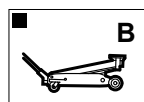
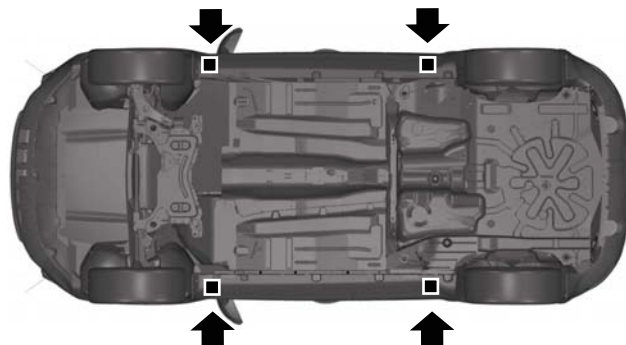

E102950

# Wheels and tyres

- A Emergency use only
- B Maintenance

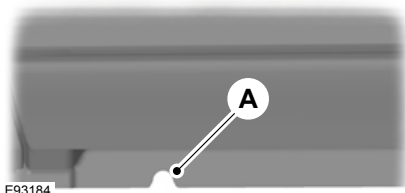

E93184

Indentations in the sills **A** show the location of the jacking points.

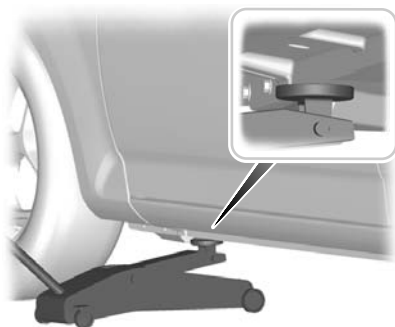

E93020

## Vehicles with side skirts



E95345

## Assembling the wheel brace

### Type one

#### WARNING



When returning the wheel brace extension to its original position, take care not to get your fingers caught.

**Note:** Make sure that the wheel brace is fully extended.



E122546

Extend the wheel brace.

### Type two

#### CAUTION



The screw-in towing eye has a **left-hand thread**. Turn it anti-clockwise to install it. Make sure that the towing eye is fully tightened.

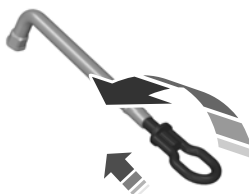

E122502

# Wheels and tyres

Insert the screw-in towing eye into the wheel brace.

## Removing the wheel trim

### Type one

Insert the flat end of the wheel brace between the rim and the trim and carefully remove the trim.

### Type two

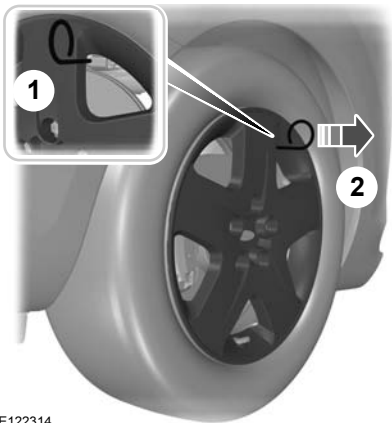



E122314

1. Insert the wheel trim remover.
2. Remove the wheel trim.









**Note:** Make sure that you pull the wheel trim remover at right angles to the trim.

## Removing a road wheel

### WARNINGS

-  Park your vehicle in such a position that neither the traffic nor you are hindered or endangered.
-  Set up a warning triangle.

### WARNINGS

-  Make sure that the vehicle is on firm, level ground with the wheels pointing straight ahead.
-  Switch off the ignition and apply the parking brake.
-  If your vehicle has a manual transmission, select first or reverse gear. If it has an automatic transmission, select park.
-  Have the passengers leave the vehicle.
-  Secure the diagonally opposite wheel with an appropriate block or wheel chock.
-  Make sure that the arrows on directional tyres point in the direction of rotation when the vehicle is moving forwards. If you have to fit a spare wheel with the arrows pointing in the opposite direction, have the tyre refitted in the correct direction by a properly trained technician.
-  Do not work underneath the vehicle when it is supported only by a jack.
-  Make sure the jack base is flat on the ground and vertically below the jacking point.

### CAUTION

-  Do not lay alloy wheels face down on the ground, this will damage the paint.

**Note:** The spare wheel is located under the floor cover in the luggage compartment.

# Wheels and tyres

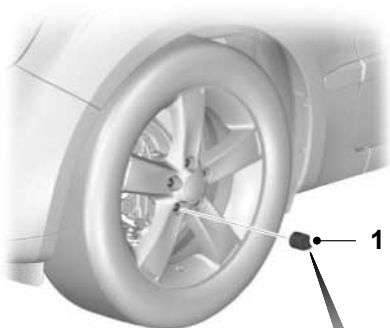

E121887

1. Install the locking wheel nut key.
2. Slacken the wheel nuts.

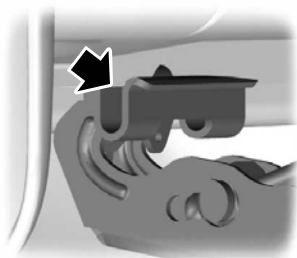

E113399

3. Install the jack to the flange.
4. Extend the jack until the base of the jack is flat on the ground, vertically below the jacking point.



E113400

5. Jack up the vehicle until the tyre is clear of the ground.
6. Remove the wheel nuts and the wheel.

## Installing a road wheel

### WARNINGS



Use only approved wheel and tyre sizes. Using other sizes could damage the vehicle and will make the National Type Approval invalid. See **Technical specifications** (page 150).



Do not fit run flat tyres on vehicles that were not originally fitted with them. Please contact your dealer for more details regarding compatibility.

### CAUTION



Do not install alloy wheels using wheel nuts designed for use with steel wheels.

**Note:** The wheel nuts of alloy wheels and spoked steel wheels can also be used for the steel spare wheel for a short time (maximum two weeks).

**Note:** Make sure the wheel and hub contact surfaces are free from foreign matter.

**Note:** Make sure that the cones on the wheel nuts are against the wheel.

# Wheels and tyres

1. Install the wheel.
2. Install the wheel nuts finger tight.
3. Install the locking wheel nut key.

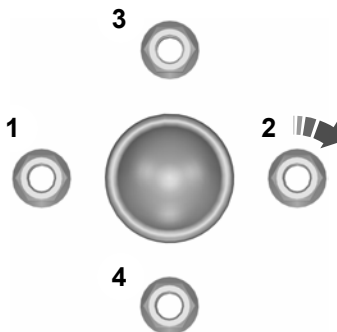

E90589

4. Partially tighten the wheel nuts in the sequence shown.
5. Lower the vehicle and remove the jack.
6. Fully tighten the wheel nuts in the sequence shown. See **Technical specifications** (page 150).
7. Install the wheel trim using the ball of your hand.

## WARNING



Have the wheel nuts checked for tightness and the tyre pressure checked as soon as possible.

## TYRE REPAIR KIT

Your vehicle may not have a spare tyre. In this case it will have an emergency tyre repair kit that can be used to repair **one** flat tyre.

The tyre repair kit is located in the spare wheel well.

## General information

### WARNINGS



Depending on the type and extent of tyre damage, some tyres can only be partially sealed or not sealed at all. Loss of tyre pressure can affect vehicle handling, leading to loss of vehicle control.



Do not use the tyre repair kit if the tyre has already been damaged as a result of being driven under inflated.



Do not use the tyre repair kit on run flat tyres.



Do not try to seal damage other than that located within the visible tread of the tyre.



Do not try to seal damage to the tyre's sidewall.

The tyre repair kit seals most tyre punctures [with a diameter of up to six millimetres (1/4 inch)] to temporarily restore mobility.

Observe the following rules when using the kit:

- **Drive with caution and avoid making sudden steering or driving manoeuvres**, especially if the vehicle is heavily loaded or you are towing a trailer.
- The kit will provide you with an emergency temporary repair, enabling you to continue your journey to the next vehicle or tyre dealer, or to drive a maximum distance of 200 kilometres (125 miles).
- Do not exceed a **maximum speed of 80 km/h (50 mph)**.

# Wheels and tyres

- Keep the kit out of the reach of children.
- Only use the kit when the ambient temperature is between  $-30^{\circ}\text{C}$  ( $-22^{\circ}\text{F}$ ) and  $+70^{\circ}\text{C}$  ( $+158^{\circ}\text{F}$ ).

## Using the tyre repair kit

### WARNINGS



Compressed air can act as an explosive or propellant.



Never leave the tyre repair kit unattended while in use.

### CAUTION



Do not keep the compressor operating for more than 10 minutes.

**Note:** Use the tyre repair kit only for the vehicle with which it was supplied.

- Park your vehicle at the roadside so that you do not obstruct the flow of traffic and so that you are able to use the kit without being in danger.
- Apply the parking brake, even if you have parked on a level road, to make sure that the vehicle will not move.
- Do not attempt to remove foreign objects like nails or screws penetrating the tyre.
- Leave the engine running while the kit is in use, but not if the vehicle is in an enclosed or poorly ventilated area (for example, inside a building). In these circumstances, switch the compressor on with the engine turned off.

- Replace the sealant bottle with a new one before the expiry date (see top of bottle) is reached.
- Inform all other users of the vehicle that the tyre has been temporarily sealed with the tyre repair kit and make them aware of the special driving conditions to be observed.

## Inflating the tyre

### WARNINGS



Check the sidewall of the tyre prior to inflation. If there are any cracks, bumps or similar damage, do not attempt to inflate the tyre.



Do not stand directly beside the tyre while the compressor is pumping.



Watch the sidewall of the tyre. If any cracks, bumps or similar damage appear, turn off the compressor and let the air out by means of the pressure relief valve **I**. Do not continue driving with this tyre.



The sealant contains natural rubber latex. Avoid contact with skin and clothing. If this happens, rinse the affected areas immediately with plenty of water and contact your doctor.



If the tyre inflation pressure does not reach 1.8 bar (26 psi) within 10 minutes, the tyre may have suffered excessive damage, making a temporary repair impossible. In this case, do not continue driving with this tyre.

## Wheels and tyres

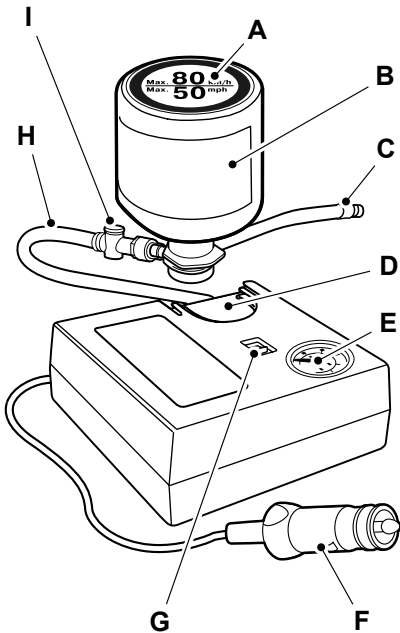

E102881

- A Label
- B Sealant bottle
- C Sealant bottle hose
- D Bottle holder
- E Pressure gauge
- F Power plug with cable
- G Compressor switch
- H Repair kit hose
- I Pressure relief valve

1. Remove the tyre repair kit from the wrapping.
  2. Peel off the label **A** showing the maximum permissible speed of 80 km/h (50 mph) from the sealant bottle and attach it to the instrument panel in the driver's field of view. Make sure the label does not obscure anything important.
  3. Take the hose **H** with the pressure relieve valve **I** and the power plug with cable **F** out of the kit.
  4. Connect the hose **H** with the pressure relieve valve **I** to the sealant bottle **B**.
  5. Engage the sealant bottle **B** into the bottle holder **D**.
  6. Remove the valve cap from the damaged tyre.
  7. Screw the sealant bottle hose **C** firmly onto the valve of the damaged tyre.
  8. Make sure that the compressor switch **G** is in position **O**.
  9. Insert the power plug **F** into the cigar lighter socket or auxiliary power socket. See **Cigar lighter** (page 85).
  10. Start the engine.
  11. Move the compressor switch **G** to position **1**.
  12. Inflate the tyre for no longer than 10 minutes to an inflation pressure of minimum 1.8 bar (26 psi) and a maximum of 3.5 bar (51 psi). Move the compressor switch **G** to position **O** and check the current tyre pressure with pressure gauge **E**.
- Note:** If a tyre pressure of 1.8 bar (26 psi) is not reached do not continue.
- Note:** When pumping in the sealant through the tyre valve, the pressure may rise up to 6 bar (87 psi) but will drop again after about 30 seconds.
13. Remove the power plug **F** from the cigar lighter socket or auxiliary power socket.

# Wheels and tyres

14. Quickly unscrew the hose **C** from the tyre valve. Fasten the valve cap again.
15. Leave the sealant bottle **B** in the bottle holder **D**.
16. Make sure the kit is stored safely, but still easily accessible in the vehicle. The kit will be required again when you check the tyre pressure.
17. Immediately drive approximately three kilometres (two miles) so that the sealant can seal the damaged area.
22. Leave hose **C** and **H** connected to the sealant bottle **B** and store the kit away safely.
23. Drive to the nearest tyre specialist to get the damaged tyre replaced. Before the tyre is removed from the rim, inform your tyre dealer that the tyre contains sealant. Renew the sealant bottle **B** and hose **C** as soon as possible after they have been used.

## WARNING



If you experience heavy vibrations, unsteady steering behaviour or noises while driving, reduce your speed and drive with caution to a place where it is safe for you to stop the vehicle. Recheck the tyre and its pressure. If the tyre pressure is less than 1 bar (14.7 psi) or if there are any cracks, bumps or similar damage visible, do not continue driving with this tyre.

18. Stop the vehicle after driving approximately three kilometres (two miles). Check, and where necessary, adjust the pressure of the damaged tyre.
19. Attach the kit and read the tyre pressure from the pressure gauge **E**.
20. Adjust it to the specified pressure. See **Technical specifications** (page 150).
21. Once you have inflated the tyre to its correct tyre pressure, move the compressor switch **G** to position **O**, remove the power plug **F** from the socket, unscrew the hose **C** and fasten the valve cap.

**Note:** Remember that emergency roadside tyre repair kits only provide temporary mobility. Regulations concerning tyre repair after usage of tyre repair kit may differ from country to country. You should consult a tyre specialist for advice.

## WARNING



Before driving, make sure the tyre is adjusted to the recommended inflation pressure. See **Technical specifications** (page 150). Monitor the tyre pressure until the sealed tyre is replaced.

Empty sealant bottles can be disposed of together with normal household waste. Return remains of sealant to your dealer or dispose of it in compliance with local waste disposal regulations.

## TYRE CARE



E70415

# Wheels and tyres

To make sure the front and rear tyres of your vehicle wear evenly and last longer, we recommend that you swap the tyres from front to rear and vice versa at regular intervals of between 5 000 and 10 000 km (3 000 and 6 000 miles).

## CAUTION

 Do not scrub the sidewalls of the tyres when you are parking.

If you have to mount a kerb, do so slowly and approach it with the wheels at right-angles to the kerb.

Examine the tyres regularly for cuts, foreign objects and uneven wear of the tread. Uneven wear could mean that the wheel alignment is outside specification.

Check the tyre pressures (including the spare) when cold, every two weeks.

## USING WINTER TYRES

### CAUTION

 Make sure that you use the correct wheel nuts for the type of wheel the winter tyres are fitted to.

If winter tyres are used, make sure that the tyre pressures are correct. See **Technical specifications** (page 150).

## TECHNICAL SPECIFICATIONS

### Wheel nut torque

Wheel type	Nm (lb-ft)
All	110 (81)

## USING SNOW CHAINS

### WARNINGS

 Do not exceed 50 km/h (30 mph).

 Do not use snow chains on snow-free roads.

 Only fit snow chains to specified tyres. See **Technical specifications** (page 150).

### CAUTION

 If your vehicle is fitted with wheel trims, remove them before fitting snow chains.

**Note:** *The ABS will continue to operate normally.*

Only use small link snow chains.

Only use snow chains on the front wheels.

### Vehicles with stability control (ESP)

Vehicles with stability control (ESP) may exhibit some unusual driving characteristics which can be avoided by switching the system off. See **Using stability control** (page 101).

# Wheels and tyres

## Tyre pressures (cold tyres)

### Up to 80 km/h (50 mph)

Variant	Tyre size	Normal load		Full load	
		Front	Rear	Front	Rear
		bar (lbf/in <sup>2</sup> )	bar (lbf/in <sup>2</sup> )	bar (lbf/in <sup>2</sup> )	bar (lbf/in <sup>2</sup> )
Temporary spare wheel when it differs from the other fitted wheels	175/65 R14	3 (44)	3 (44)	3 (44)	3 (44)

### Up to 160 km/h (100mph)

Variant	Tyre size	Normal load		Full load	
		Front	Rear	Front	Rear
		bar (lbf/in <sup>2</sup> )	bar (lbf/in <sup>2</sup> )	bar (lbf/in <sup>2</sup> )	bar (lbf/in <sup>2</sup> )
All engines except 1.6L Duratorq-TDCi (DV) Diesel	175/65 R14*	2.1 (31)	1.8 (26)	2.4 (35)	3.2 (46)
All engines except 1.6L Duratorq-TDCi (DV) Diesel	195/50 R15	2.1 (31)	1.8 (26)	2.4 (35)	3.2 (46)
All engines except 1.6L Duratorq-TDCi (DV) Diesel	195/45 R16	2.2 (32)	1.8 (26)	2.4 (35)	3.2 (46)
All engines except 1.6L Duratorq-TDCi (DV) Diesel	205/40 R17	2.2 (32)	1.8 (26)	2.4 (35)	2.8 (41)
All engines except 1.6L Duratorq-TDCi (DV) Diesel	195/60 R15	2.1 (31)	2.1 (31)	2.4 (35)	2.6 (38)
1.6L Duratorq-TDCi (DV) Diesel	175/65 R14*	2.3 (33)	1.8 (26)	2.4 (35)	3.2 (46)
1.6L Duratorq-TDCi (DV) Diesel	195/50 R15	2.3 (33)	1.8 (26)	2.4 (35)	3.2 (46)

## Wheels and tyres

Variant	Tyre size	Normal load		Full load	
		Front	Rear	Front	Rear
		bar (lbf/in <sup>2</sup> )	bar (lbf/in <sup>2</sup> )	bar (lbf/in <sup>2</sup> )	bar (lbf/in <sup>2</sup> )
1.6L Duratorq-TDCi (DV) Diesel	195/45 R16	2.3 (33)	1.8 (26)	2.4 (35)	3.2 (46)
1.6L Duratorq-TDCi (DV) Diesel	205/40 R17	2.3 (33)	1.8 (26)	2.4 (35)	2.8 (41)
1.6L Duratorq-TDCi (DV) Diesel	195/60 R15	2.1 (31)	2.1 (31)	2.4 (35)	2.6 (38)

\* Only fit snow chains to specified tyres.

### Continuous speed in excess of 160 km/h (100mph)

Variant	Tyre size	Normal load		Full load	
		Front	Rear	Front	Rear
		bar (lbf/in <sup>2</sup> )	bar (lbf/in <sup>2</sup> )	bar (lbf/in <sup>2</sup> )	bar (lbf/in <sup>2</sup> )
All engines except 1.6L Duratorq-TDCi (DV) Diesel	175/65 R14*	2.1 (31)	2 (29)	2.6 (38)	3.2 (46)
All engines except 1.6L Duratorq-TDCi (DV) Diesel	195/50 R15	2.1 (31)	2 (29)	2.6 (38)	3.2 (46)
All engines except 1.6L Duratorq-TDCi (DV) Diesel	195/45 R16	2.1 (31)	2 (29)	2.6 (38)	3.2 (46)
All engines except 1.6L Duratorq-TDCi (DV) Diesel	205/40 R17	2.1 (31)	2 (29)	2.6 (38)	2.8 (41)
All engines except 1.6L Duratorq-TDCi (DV) Diesel	195/60 R15	2.1 (31)	2.1 (31)	2.6 (38)	2.6 (38)
1.6L Duratorq-TDCi (DV) Diesel	175/65 R14*	2.3 (33)	2 (29)	2.6 (38)	3.2 (46)

## Wheels and tyres

Variant	Tyre size	Normal load		Full load	
		Front	Rear	Front	Rear
		bar (lbf/ in <sup>2</sup> )	bar (lbf/ in <sup>2</sup> )	bar (lbf/ in <sup>2</sup> )	bar (lbf/ in <sup>2</sup> )
1.6L Duratorq-TDCi (DV) Diesel	195/50 R15	2.3 (33)	2 (29)	2.6 (38)	3.2 (46)
1.6L Duratorq-TDCi (DV) Diesel	195/45 R16	2.3 (33)	2 (29)	2.6 (38)	3.2 (46)
1.6L Duratorq-TDCi (DV) Diesel	205/40 R17	2.3 (33)	2 (29)	2.6 (38)	2.8 (41)
1.6L Duratorq-TDCi (DV) Diesel	195/60 R15	2.1 (31)	2.1 (31)	2.6 (38)	2.6 (38)

\* Only fit snow chains to specified tyres.

# Vehicle identification

## VEHICLE IDENTIFICATION PLATE

**Note:** The vehicle identification plate design may vary to that shown.

**Note:** The information shown on the vehicle identification plate is dependant upon market requirements.

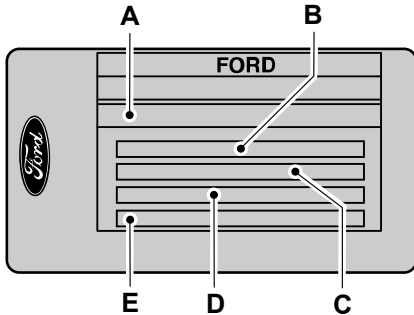

E85610

- A Vehicle identification number
- B Gross vehicle weight
- C Gross train weight
- D Maximum front axle weight
- E Maximum rear axle weight

The vehicle identification number and maximum weights are shown on a plate located at the bottom of the right-hand side door aperture.

## VEHICLE IDENTIFICATION NUMBER (VIN)

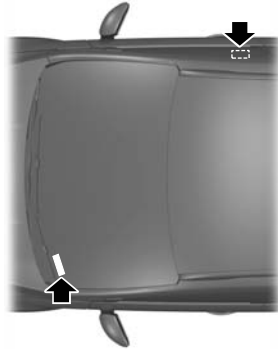

E87496

The vehicle identification number is stamped into the floor panel on the right-hand side, beside the front seat. It is also shown on the left-hand side of the instrument panel.

# Technical specifications

## TECHNICAL SPECIFICATIONS

### Vehicle dimensions 3-door, 5-door and van

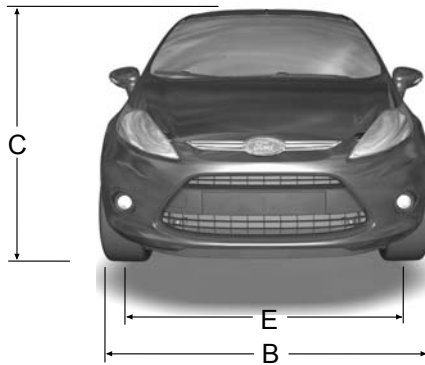
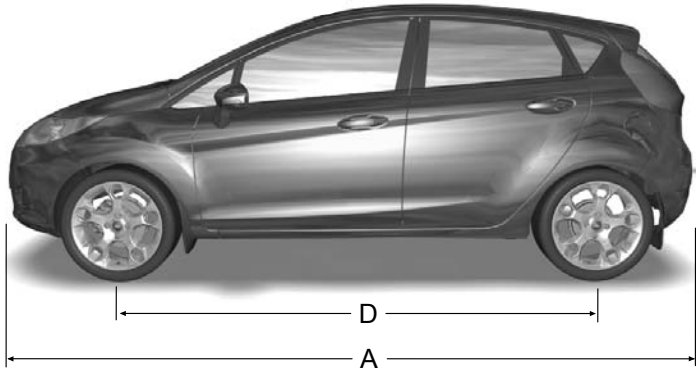

E101870

Item	Dimension description	Dimension in mm (inches)
A	Maximum length	3 950 - 3 958 (155.5 - 155.8)
B	Overall width including exterior mirrors	1 973 (77.7)

## Technical specifications

---

<b>Item</b>	<b>Dimension description</b>	<b>Dimension in mm (inches)</b>
C	Overall height at EC kerb weight	1 433 - 1 481 (56.4 - 58.3)
D	Wheelbase	2 489 (98)
E	Front track	1 473 - 1 493 (58 - 58.8)
E	Rear track	1 460 - 1 480 (57.5 - 58.3)

# Technical specifications

## Towing equipment dimensions 3-door, 5-door and van

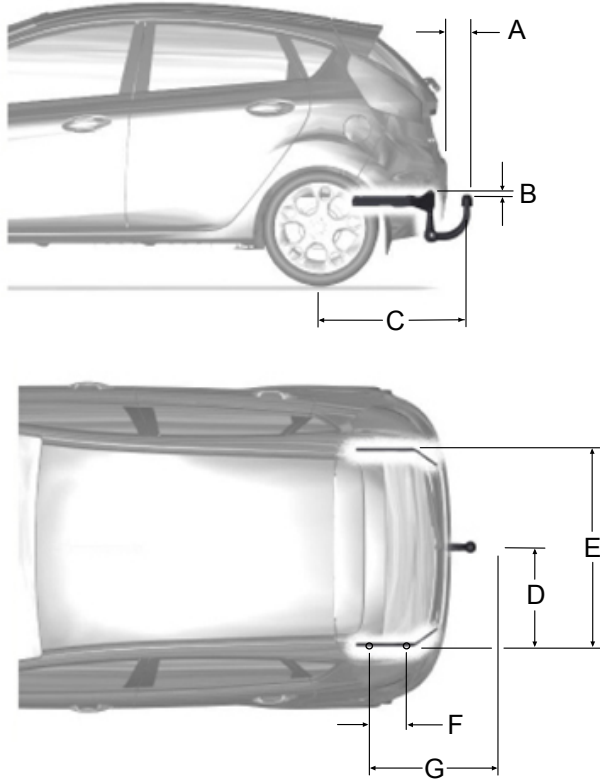

E101872

Item	Dimension description	Dimension in mm (inches)
A	Bumper – end of tow ball	124 (4.9)
B	Attachment point – centre of tow ball	7 (0.3)
C	Wheel centre – centre of tow ball	761 (29.9)
D	Centre of tow ball – side member	512 (20.2)
E	Outer side of side member	1 024 (40.3)

## Technical specifications

---

<b>Item</b>	<b>Dimension description</b>	<b>Dimension in mm (inches)</b>
F	Centre of first attachment point – centre of second attachment point	267 (10.5)
G	Centre of tow ball – centre of second attachment point	584 (23)

# Audio introduction

## IMPORTANT AUDIO INFORMATION

### WARNINGS



Due to technical incompatibility, recordable (CD-R) and rewritable (CD-RW) discs may not function correctly.



These CD radio units will play compact discs that conform to the International Red Book standard audio specification. Copy protected CDs from some manufacturers do not conform to this standard and playback cannot be guaranteed.



Dual format, dual sided discs (DVD Plus, CD-DVD format), adopted by the music industry, are thicker than normal CDs and consequently playback cannot be guaranteed, and jamming could occur. Irregular shaped CDs and CDs with a scratch protection film or self adhesive labels attached should not be used. Warranty claims, where this type of disc is found to be inside an audio unit returned for repair, will not be accepted.



All CD units are designed to play commercially pressed 12 cm audio compact discs only.



The audio unit may be damaged if unsuitable items like credit cards or coins are pushed inside the CD aperture.

CAUTION—INVISIBLE LASER RADIATION WHEN OPEN  
DO NOT STARE INTO BEAM OR  
VIEW DIRECTLY WITH OPTICAL INSTRUMENTS

## Disc labels

### Audio CD



### MP3



## Audio unit labels

CLASS 1  
LASER PRODUCT

# Audio unit overview

## AUDIO UNIT OVERVIEW

**Note:** Units have an integrated multi function display situated above the CD aperture. This shows important information regarding control of your audio unit. Additionally, there are various icons placed around the display screen which light up when a function is active (for example CD, Radio or Aux.)

### Type 1

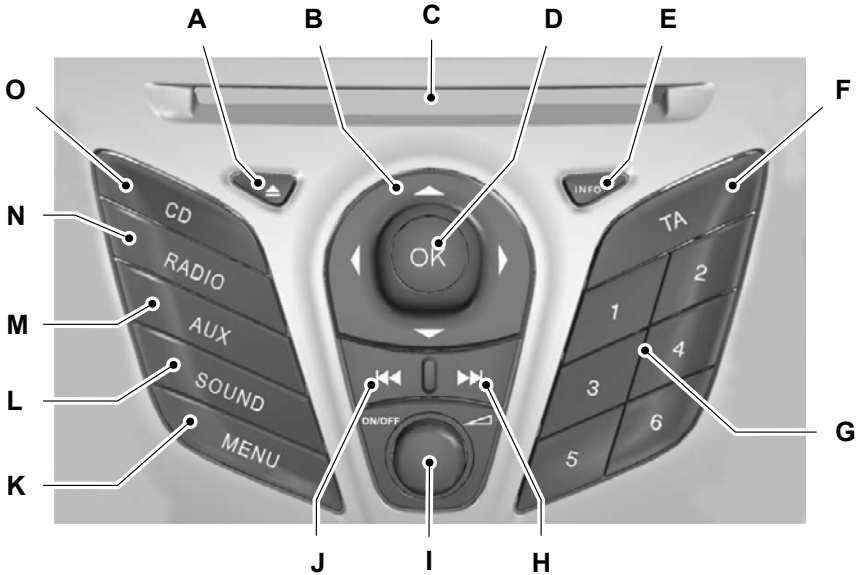

E103293

- A CD eject. See **Compact disc player** (page 172).
- B Navigation arrows.
- C CD aperture. See **Compact disc player** (page 172).
- D OK.
- E Information.
- F Traffic announcement. See **Traffic information control** (page 168).

# Audio unit overview

- G Station presets. See **Station preset buttons** (page 168).
- H Seek up. CD track selection. See **Station tuning control** (page 167). See **Track selection** (page 172).
- I On/off and volume control.
- J Seek down. CD track selection. See **Station tuning control** (page 167). See **Track selection** (page 172).
- K Menu select.
- L Sound button. See **Sound button** (page 167).
- M Auxiliary select. See **Auxiliary input (AUX IN) socket** (page 86). See **Auxiliary input (AUX IN) socket** (page 176).
- N Radio and waveband select. See **Audio unit operation** (page 167).
- O CD select. See **Compact disc player** (page 172).

## Type 2

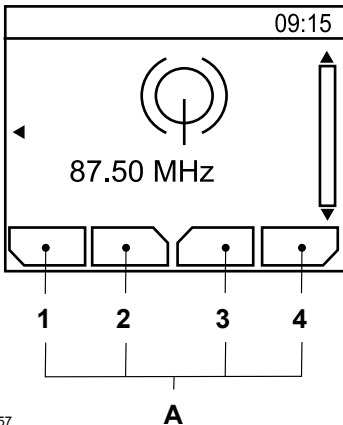

E104157

- A Descriptions for function buttons 1-4

## Audio unit overview

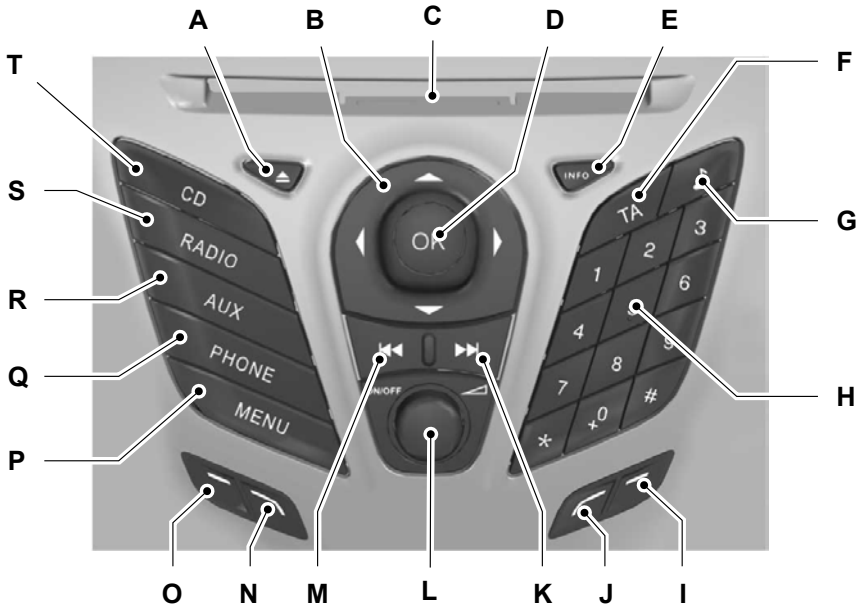

E103294

- A CD eject. See **Compact disc player** (page 172).
- B Navigation arrows.
- C CD aperture. See **Compact disc player** (page 172).
- D OK.
- E Information.
- F Traffic announcement. See **Traffic information control** (page 168).
- G Sound button. See **Sound button** (page 167).
- H Telephone keypad and station presets. See **Using the telephone** (page 179). See **Station preset buttons** (page 168).
- I Function 4.
- J Function 3.
- K Seek up. CD track selection. See **Station tuning control** (page 167). See **Track selection** (page 172).

# Audio unit overview

- L On/off and volume control.
- M Seek down. CD track selection. See **Station tuning control** (page 167). See **Track selection** (page 172).
- N Function 2.
- O Function 1.
- P Menu select.
- Q Phone menu. See **Telephone** (page 178).
- R Auxiliary, USB and iPod select. See **Auxiliary input (AUX IN) socket** (page 86). See **Auxiliary input (AUX IN) socket** (page 176). See **Connectivity** (page 198).
- S Radio and waveband select. See **Audio unit operation** (page 167).
- T CD select. See **Compact disc player** (page 172).

Function buttons 1 to 4 are context dependent, and change according to the current unit mode. Descriptions for the functions are shown at the bottom of the screen display.

Type 3

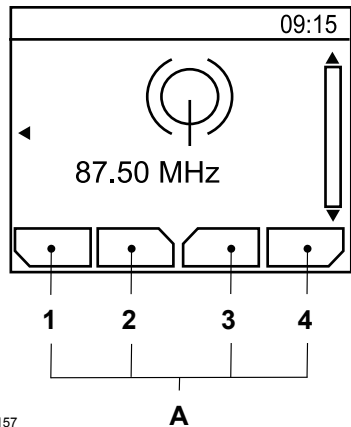

E104157

- A Descriptions for function buttons 1-4

## Audio unit overview

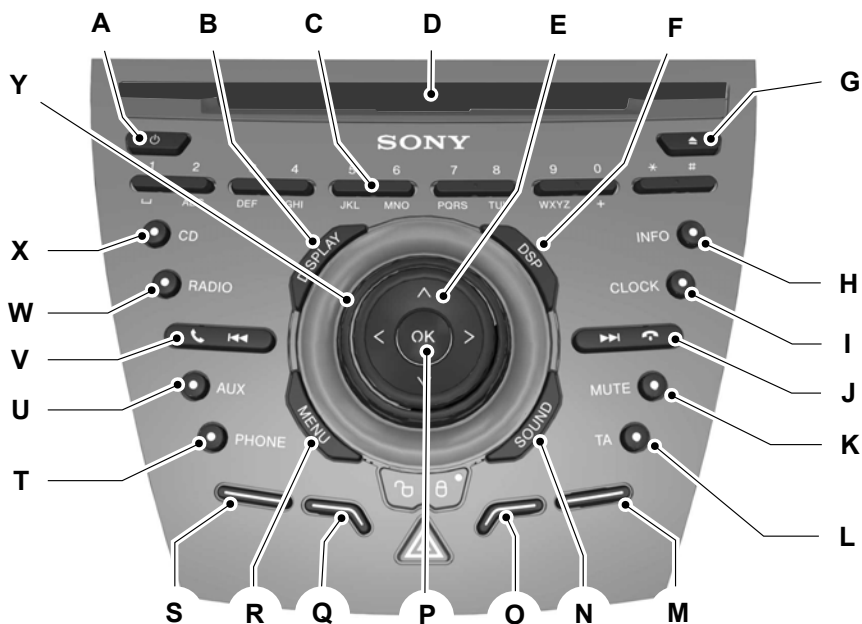

E129074

- A On/off control.
- B Display select.
- C Telephone keypad and station presets. See **Using the telephone** (page 179). See **Station preset buttons** (page 168).
- D CD aperture. See **Compact disc player** (page 172).
- E Navigation arrows.
- F DSP select. See **Digital signal processing (DSP)** (page 170).
- G CD eject. See **Compact disc player** (page 172).
- H Information.
- I Clock.
- J Seek up. CD track selection. End call. See **Station tuning control** (page 167). See **Track selection** (page 172). See **Using the telephone** (page 179).

# Audio unit overview

---

- K Mute.
- L Traffic announcement. See **Traffic information control** (page 168).
- M Function 4.
- N Sound button. See **Sound button** (page 167).
- O Function 3.
- P OK.
- Q Function 2.
- R Menu select.
- S Function 1.
- T Phone menu. See **Telephone** (page 178).
- U Auxiliary select. See **Auxiliary input (AUX IN) socket** (page 86). See **Auxiliary input (AUX IN) socket** (page 176).
- V Seek down. CD track selection. Accept call. See **Station tuning control** (page 167). See **Track selection** (page 172). See **Using the telephone** (page 179).
- W Radio and waveband select. See **Audio unit operation** (page 167).
- X CD select. See **Compact disc player** (page 172).
- Y Volume control.

Function buttons 1 to 4 are context dependent, and change according to the current unit mode. Descriptions for the functions are shown at the bottom of the screen display.

# Audio system security

---

## **SECURITY CODE**

Each unit incorporates a unique code that is linked to the vehicle identification number (VIN). The system will automatically check that the audio unit and vehicle match before allowing operation.

If a security code message appears, please see your dealer.

# Audio unit operation

---

## ON/OFF CONTROL

Press the on/off control. This will also operate the unit for up to one hour with the ignition turned off.

The radio will switch off automatically after one hour.

## SOUND BUTTON

This will allow you to adjust the sound settings (for example bass and treble).

1. Press the sound button.
2. Use the up and down arrow buttons to select the required setting.
3. Use the left and right arrow buttons to make the necessary adjustment. The display indicates the level selected.
4. Press the **OK** button to confirm the new settings.

## WAVEBAND BUTTON

Press the RADIO button to select from the wavebands available.

The selector can also be used to return to radio reception when you have been listening to another source.

Alternatively, press the left arrow button to display the available wavebands. Scroll to the required waveband and press OK.

## STATION TUNING CONTROL

### Seek tuning

Select a waveband and briefly press one of the seek buttons. The unit will stop at the first station it finds in the direction you have chosen.

## Manual tuning

### Type 1

1. Press the MENU button.
2. Select RADIO mode and then MANUAL TUNE.
3. Use the left and right arrow buttons to tune down or up the waveband in small increments or press and hold to increment quickly, until you find a station you want to listen to.
4. Press OK to continue listening to a station.

### Type 2 and 3

1. Press function button 2.
2. Use the left and right arrow buttons to tune down or up the waveband in small increments or press and hold to increment quickly, until you find a station you want to listen to.
3. Press OK to continue listening to a station.

## Scan tuning

Scan allows you to listen to a few seconds of each station detected.

### Type 1

1. Press the MENU button.
2. Select RADIO mode and then SCAN.
3. Use the seek buttons to scan up or down the selected waveband.
4. Press OK to continue listening to a station.

### Type 2 and 3

1. Press function button 3.
2. Use the seek buttons to scan up or down the selected waveband.
3. Press function button 3 again or OK to continue listening to a station.

# Audio unit operation

---

## STATION PRESET BUTTONS

This feature allows you to store your favourite stations so that they can be recalled by selecting the appropriate waveband and pressing one of the preset buttons.

1. Select a waveband.
2. Tune to the station required.
3. Press and hold one of the preset buttons. A progress bar and message will appear. When the progress bar completes the station has been stored. The audio unit will also mute momentarily as confirmation.

This can be repeated on each waveband and for each preset button.

Whilst in radio mode, stored stations can also be selected by pressing the arrow up, down, right or OK buttons. Then scroll to the desired preset station and press OK.

**Note:** *When you drive to another part of the country, FM stations that broadcast on alternative frequencies, and are stored on preset buttons, may be updated with the correct frequency for that area.*

## AUTOSTORE CONTROL

**Note:** *This will store up to a maximum of the 10 strongest signals available, either from the AM or the FM waveband, and overwrite the previously stored stations. It can also be used to store stations manually in the same way as other wavebands.*

**Note:** *On type 3 you must select either FM AST or AM AST to use this function.*

- Press and hold function button 1 or the RADIO button.
- When the search is complete, sound is restored and the strongest signals are stored on the Autostore presets.

## TRAFFIC INFORMATION CONTROL

Many stations that broadcast on the FM waveband have a TP code to signify that they carry traffic programme information.

### Activating traffic announcements

Before you can receive traffic announcements, you must press either the TA or TRAFFIC button. A 'TA' display will appear to show the feature is switched on.

If you are already tuned to a station that broadcasts traffic information, 'TP' will also be displayed. Otherwise the unit will search for a traffic programme.

When traffic information is broadcast, it will automatically interrupt normal radio or CD playback and 'Traffic announcement (TA)' will appear in the display.

If a non-traffic station is selected or recalled using a preset button, the audio unit will remain on that station unless TA or TRAFFIC is turned off, then on again.

**Note:** *If TA is on and you select a preset or manual tune to a non TA station no traffic announcement will be heard.*

**Note:** *When you are listening to a non TA station and turn TA off and on again a TP seek will occur.*

# Audio unit operation

---

## Traffic announcement volume

Traffic announcements interrupt normal broadcasts at a preset minimum level that is usually louder than normal listening volumes.

To adjust the preset volume:

- Use the volume control to make the necessary adjustment during an incoming TA broadcast. The display will show the level selected.

## Ending traffic announcements

The audio unit will return to normal operation at the end of each traffic announcement. To end the announcement prematurely, press TA or TRAFFIC during the announcement.

**Note:** *If you press TA or TRAFFIC at any other time it will switch all announcements off.*

# Audio unit menus

---

## **AUTOMATIC VOLUME CONTROL**

When available, automatic volume control (AVC) adjusts the volume level to compensate for engine noise and road speed noise.

1. Press the MENU button and select AUDIO.
2. Select AVC LEVEL or ADAPTIVE VOL.
3. Use the left or right arrow button to adjust the setting.
4. Press the OK button to confirm your selection.
5. Press the MENU button to return.

## **DIGITAL SIGNAL PROCESSING (DSP)**

### **DSP occupancy**

This feature takes into account the differences in distance from the various speakers in the vehicle to each seat. Select the sitting position for which the audio is to be correctly enhanced.

### **DSP equaliser**

Select the music category that most suits your listening preference. The audio output will change to enhance the particular style of music chosen.

### **Changing the DSP settings**

1. Press the MENU button.
2. Select AUDIO or AUDIO SETTINGS.
3. Scroll to the required DSP function.
4. Use the up and down arrow buttons to select the required setting.
5. Press the OK button to confirm your selection.
6. Press the MENU button to return.

## **NEWS BROADCASTS**

Some audio units interrupt normal reception to broadcast news bulletins from stations on the FM waveband or radio data system (RDS) and enhanced other network (EON) linked stations, in the same way as traffic information is provided.

During news broadcasts, the display will indicate there is an incoming announcement. News interrupts are broadcast at the same preset volume level as traffic announcements.

1. Press the MENU button.
2. Select AUDIO or AUDIO SETTINGS.
3. Scroll to NEWS and turn on or off with the OK button.
4. Press the MENU button to return.

## **ALTERNATIVE FREQUENCIES**

Many programmes that broadcast on the FM waveband have a programme identification (PI) code, which can be recognised by audio units.

If your radio has alternative frequencies (AF) tuning switched on and you move from one transmission area to another, this facility will search for and switch to a stronger station signal, if one can be found.

Under certain conditions, however, AF tuning may temporarily disrupt normal reception.

## Audio unit menus

---

When selected, the unit continually evaluates signal strength and, if a better signal becomes available, the unit will switch to that alternative. It mutes while it checks a list of alternative frequencies and, if necessary, it will search once across the selected waveband for a genuine alternative frequency.

It will restore radio reception when it finds one or, if one is not found, the unit will return to the original stored frequency.

When selected, 'AF' will be shown in the display.

1. Press the MENU button.
2. Select AUDIO or AUDIO MENU.
3. Scroll to ALTERNAT FREQ. or ALTERNATIVE FREQ. and turn on or off with the OK button.
4. Press the MENU button to return.

1. Press the MENU button.
2. Select AUDIO or AUDIO SETTINGS.
3. Scroll to RDS REGIONAL and turn on or off with the OK button.
4. Press the MENU button to return.

### REGIONAL MODE (REG)

Regional mode (REG) controls the behaviour of AF switching between regionally related networks of a parent broadcaster. A broadcaster may run a fairly large network across a large part of the country. At various times of the day this large network may be broken down into a number of smaller regional networks, typically centred on major towns or cities. When the network is not split into regional variants, the whole network carries the same programming.

Regional mode ON: This prevents 'random' AF switches when neighbouring regional networks are not carrying the same programming.

Regional mode OFF: This allows a larger coverage area if neighbouring regional networks are carrying the same programming, but can cause 'random' AF switches if they are not.

# Compact disc player

---

## COMPACT DISC PLAYBACK

**Note:** During playback, the display indicates the disc, track and time that has elapsed since the start of the track.

During radio reception, press the CD button once to start CD playback.

Playback will start immediately after a disc is loaded.

## TRACK SELECTION

- Press the seek up button once to move to the next track or press it repeatedly to access later tracks.
- Press the seek down button once to replay the current track. If pressed within two seconds of the start of a track, the previous track will be selected.
- Press the seek down button repeatedly to select previous tracks.
- Press the up or down arrow buttons, and using the OK button, select the required track.

### Type 2 and 3

The desired track number may be entered using the numeric keypad. Dial the required track number until complete (for example 1 then 2 for track 12), or dial the number and directly press OK.

## FAST FORWARD/REVERSE

Press and hold the seek down or up buttons to search backwards or forwards within the tracks on the disc.

## SHUFFLE/RANDOM

Random track playback, also known as shuffle, plays all tracks on the CD in random order.

### Type 1

1. Press the MENU button and select CD MODE.
2. Select SHUFFLE, which then enables the function to be selected on or off.

When an MP3 CD is playing, options include SHUFFLE for the whole CD, or to play all the tracks in the folder in a random order.

### Type 2 and 3

Press function button 2.

**Note:** When an MP3 CD is playing, options include SHUFFLE for the whole CD, or to play all the tracks in the folder in a random order. Repeat presses of function button 2 will toggle these options.

Use the seek up or down button to select the next track to shuffle if required.

## REPEAT COMPACT DISC TRACKS

### Type 1

1. Press the MENU button and select CD MODE.
2. Select REPEAT, which then enables the function to be selected on or off. The track will replay once ended.

When an MP3 CD is playing, options include REPEAT for the track, or to repeat all the tracks in the folder.

### Type 2 and 3

Press function button 1.

# Compact disc player

---

When an MP3 CD is playing, options include REPEAT for the track, or to repeat all the tracks in the folder. Repeat presses of function button 1 will toggle these options.

## COMPACT DISC TRACK SCANNING

The SCAN function allows you to preview each track for approximately 5 seconds.

### Type 1

Various scan modes are possible, according to the type of CD currently playing.

1. Press the MENU button and select CD MODE.
2. Select SCAN, which then enables the function to be selected on or off.

**Note:** *When an MP3 CD is playing, options include SCAN for the CD, or just the tracks in the folder.*

3. Press the OK button to stop the scan mode.

### Type 2 and 3

1. Press function button 3.

**Note:** *When an MP3 CD is playing, options include SCAN for the CD, or just the tracks in the folder. Repeat presses of function button 3 will toggle these options.*

2. Press function button 3 again to stop the scan mode.

## MP3 FILE PLAYBACK

MP3 (MPEG 1 Audio Layer-3) is a standard technology and format for compressing audio data. This allows a more efficient use of the media.

You can play MP3 files recorded on CD-ROMs, CD-Rs, and CD-RWs. The disc must be in the ISO 9660 level 1 or level 2 format, or Joliet or Romeo in the expansion format. You can also use a disc recorded in Multi Session.

## ISO 9660 format

This is the most common international standard for the logical format of files and folders on a CD-ROM.

There are several specification levels. In Level 1, file names must be in the 8.3 format (no more than 8 characters in the name, no more than 3 characters in the extension ".MP3") and in capital letters.

Folder names can be no longer than 8 characters. There can be no more than 8 folder levels (trees). Level 2 specifications allow file names up to 31 characters long.

Each folder can have up to 8 trees.

For Joliet or Romeo in the expansion format, please consider these restrictions when configuring your CD writing software.

## Multi session

This is a recording method that enables adding of data using the Track-At-Once method.

Conventional CDs begin at a CD control area called the Lead-in and end at an area called Lead-out. A Multi Session CD is a CD having multiple sessions, with each segment from Lead-in to Lead-out regarded as a single session.

- CD-Extra: The format that records audio (audio CD data) as tracks on session 1, and records data as tracks on session 2.
- Mixed CD: In this format, data is recorded as track 1, and audio (audio CD data) is recorded as track 2.

# Compact disc player

## File formats

- With formats other than ISO 9660 level 1 and level 2, folder names or file names may not be displayed correctly.
- When naming, be sure to add the file extension “.MP3” to the file name.
- If you put the extension “.MP3” to a file other than MP3, the unit cannot recognize the file properly and will generate random noise that could damage your speakers.
- The following discs take a longer time to start playback.
  - a disc recorded with complicated tree structure.
  - a disc recorded in Multi Session.
  - a non-finalised disc to which data can be added.

## Playing a multi session disc

### When the first track of the first session is audio CD data

Only audio CD data of the first session is played back. Non-audio CD data/MP3 file information (track number, time, etc.) is displayed with no sound.

### When the first track of the first session is not audio CD data

- If an MP3 file is in the disc, only MP3 file(s) play back and other data is skipped. (Audio CD data is not recognised.)
- If no MP3 file is in the disc, nothing is played back. (Audio CD data is not recognised.)

## MP3 files playback order

The playback order of the folders and files is as shown.

**Note:** A folder that does not include an MP3 file is skipped.

**Playback tip:** To specify a desired playback order, before the folder or file name, input the order by number (e.g., “01,” “02”), then record contents onto a disc. (The order differs depending on the writing software.)

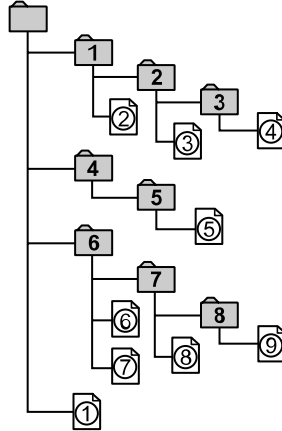

E104206

## ID3 Tag Version 2

The following occurs when an MP3 file containing ID3 tag ver.2 is played:

- When skipping a portion of ID3 tag ver.2 (at the beginning of the track), sound is not output. Skip time changes depending ID3 tag ver.2 capacity. Example: At 64 kbytes, it is about 2 seconds (with RealJukebox).
- The displayed elapsed playing time when skipping a portion of ID3 tag ver.2 is inaccurate. For MP3 files of a bit rate other than 128 kbps, time is not displayed accurately during playback.
- When an MP3 file is created with MP3 conversion software (e.g. RealJukebox - a registered trademark of RealNetworks Inc), ID3 ver.2 will automatically be written.

# Compact disc player

---

## MP3 navigation

MP3 tracks may be recorded on the CD in several ways. They can all be placed in the root directory like a conventional audio CD, or they can be placed in folders that may represent, for example, an album, an artist, or a genre.

The normal playing sequence on CDs with multiple folders is to play the tracks within the root (top level) first, then the tracks in any folder(s) within the root, then move onto the second folder, and so forth.

- Press the up or down arrow buttons to enter the track list.
- Navigate the hierarchy using the arrow buttons to select another folder or track (file).
- Press OK to select a highlighted track.

## MP3 DISPLAY OPTIONS

**Note:** *Type 1 units may require repeated button presses of the INFO button to display all the available track information.*

When an MP3 disc is playing, certain information encoded in each track can be displayed. Such information will normally include:

- The file name
- The folder name
- ID3 information which might be the album or artist's name

The unit will normally show the file name that is playing. To select one of the other items of information:

- Press the INFO button.

## CD text display options

When an audio disc with CD text is playing, limited information encoded in each track can be displayed. Such information will normally include:

- The disc name
- The artist name
- The track name

These display options are selected in the same way as MP3 displays.

## ENDING COMPACT DISC PLAYBACK

To restore radio reception on all units:

- Press the RADIO button.

**Note:** *This will not eject the CD; the disc will merely pause at the point where radio reception was restored.*

To resume CD playback, press the CD button again.

# Auxiliary input (AUX IN) socket

---

## AUXILIARY INPUT (AUX IN) SOCKET

**Note:** *For optimum performance when using any auxiliary device set the volume on the device high. This will reduce audio interference when charging the device via the vehicle power supply socket.*

When fitted the Auxiliary input (AUX IN) socket permits an auxiliary device, such as an MP3 player, to be linked into the vehicle audio system. Output can be played through the vehicle speakers.

To connect an auxiliary device, plug it into the AUX IN socket using a 3.5 mm conventional audio jack connector.

Select the auxiliary input via the AUX button and playback will be heard through the vehicle speakers. LINE IN or LINE IN ACTIVE will appear in the vehicle audio unit display. Volume, treble and bass can be adjusted on the vehicle audio unit as normal.

The vehicle audio unit buttons can also be used to restore playback from the vehicle audio unit, while the auxiliary device remains connected.

# Audio troubleshooting

---

## AUDIO TROUBLESHOOTING

<b>Audio unit display</b>	<b>Rectification</b>
PLEASE CHECK CD	General error message for CD fault conditions, such as cannot read the CD, data-CD inserted, etc. Ensure disc is loaded correct way up. Clean and re-try, or replace disc with known music disc. If error persists contact your dealer.
CD DRIVE MALFUNCTION	General error message for CD fault conditions such as possible mechanism fault.
CD DRIVE HIGH TEMP	Ambient temperature too hot – unit will not work until it has cooled down.
IPOD ERROR READING DEVICE	General error message for iPod fault conditions, such as cannot read the data. Ensure iPod is inserted correctly. If error persists contact your dealer.

# Telephone

---

## GENERAL INFORMATION

### CAUTION

 Using the system with the engine off will drain the battery.

This section describes the functions and features of the Bluetooth mobile phone hands free system.

The Bluetooth mobile phone part of the system provides interaction with the audio or navigation system and your mobile phone. It allows you to use the audio or navigation system to make and receive calls without having to hold your mobile phone.

## Compatibility of phones

### CAUTION

 As no common agreement exists, mobile phone manufacturers are able to implement a variety of profiles in their Bluetooth devices. Because of this, an incompatibility can occur between the phone and hands-free system, which in some cases may significantly degrade the system performance. To avoid this situation, only recommended phones should be used.

Please visit the website [www.ford-mobile-connectivity.com](http://www.ford-mobile-connectivity.com) for full details.

## BLUETOOTH SETUP

Before you can use your telephone with your vehicle it must be bonded to the vehicle telephone system.

### Handling of phones

Up to six Bluetooth devices can be bonded to the vehicle system.

**Note:** *If there is an ongoing call when the phone in use is selected as the new active phone, the call is transferred to the vehicle audio system.*

**Note:** *Even if connected to the car system, your phone can still be used in the usual way.*

## Requirements for Bluetooth connection

The following are required before a Bluetooth phone connection can be made.

1. The Bluetooth feature must be activated on the phone and on the audio unit. Make sure the Bluetooth menu option in the audio unit is set to **ON**. For information on phone settings, refer to your phone user guide.
2. In the Bluetooth menu on your phone, search for **Ford Audio** and select it.
3. Enter the code number shown on the vehicle display using the phone keypad. If no code number is shown on the display, enter the Bluetooth PIN number 0000 using the phone keypad. Now enter the Bluetooth PIN number shown on the vehicle display.
4. If your mobile phone asks you to authorize the automatic connection, select **YES**.

**Note:** *A phone call will be disconnected if the audio unit is switched off. If the ignition key is turned to the off position the phone call will remain in progress.*

## TELEPHONE SETUP

### Phonebook

**Note:** *It may be necessary to confirm phonebook access to the Bluetooth system via the mobile phone.*

# Telephone

After start up access to the phonebook list can be delayed for several minutes, depending upon the size.

## Phonebook categories

The category is indicated as an icon:



Phone



Mobile



Home



Office

## Making a phone an active phone

**Note:** If there is an ongoing call when the phone in use is selected as the new active phone, the call is transferred to the vehicle audio system.

When using the system for the first time, no phone is connected to the system.

After switching on the ignition and the audio unit, the Bluetooth phone must be bonded to the system. See **Bluetooth setup** (page 178).

After bonding a Bluetooth phone to the system, this becomes the active phone. For further information refer to the phone menu.

Select the phone from the active phone menu.

Turning the ignition and radio back on again, the last active phone is picked up by the system.

**Note:** In some cases the Bluetooth connection must also be confirmed on the phone.

## Bond another Bluetooth phone

Bond a new Bluetooth phone as described in the requirements for a Bluetooth connection.

Phones stored in the system are accessible by using the phone list on the audio unit.

**Note:** A maximum of six devices may be bonded. If six Bluetooth devices have already been bonded, one of these has to be debonded in order to bond a new device.

## TELEPHONE CONTROLS

### Remote control

#### Voice and mode button



E102756

Incoming calls can be accepted by pressing the MODE button once. Press the button again to end the call.

## USING THE TELEPHONE

**Note:** Refer to your audio guide for details of the controls. See **Audio unit overview** (page 160).

**Note:** You can exit the phone menu by pressing any source button **CD**, **RADIO** or **AUX**.

# Telephone

---

**Note:** When referred to, the use of the up/down arrow buttons, seek up and seek down buttons, and the **OK** button can be used on either the steering wheel or the audio unit.

This chapter describes the phone functions of the audio unit.

An active phone must be present.

Even if connected to the audio unit, your phone can still be used in the usual way.

## Making a call

### Dialling a number using voice control

Phone numbers can be dialled using voice control. See **Telephone commands** (page 190).

### Dialling a number using the address book

1. Press the **PHONE** button.
2. Press the up/down arrow buttons until **PHONEBOOK** is shown.
3. Press the **OK** button.

**Note:** You can also use the telephone keypad to select the first letter of the entry you are looking for. Press the relevant number that corresponds to the letter repeatedly until the required letter is displayed.

4. Press the up/down arrow buttons to select the desired phone number.

**Note:** Press and hold the up/down arrow buttons to search forwards or backwards within the phonebook.

5. Press the **OK** button to dial the selected phone number.

### Dialling a number using the telephone keypad

1. Press the **PHONE** button.

2. Dial the number using the telephone keypad on the audio unit.
3. Press the **OK** button.

**Note:** If you enter an incorrect digit whilst entering a phone number, press function button 3 to erase the last digit. A long press will erase the complete string of digits.

## Ending a call

Calls can be ended by:

- pressing the seek up button
- pressing the **OK** button
- pressing function button 4.

## Redialling a number

1. Press the **PHONE** button.
2. Press the up/down arrow buttons until **CALL LISTS** is displayed.
3. Press the **OK** button.

**Note:** If the active phone does not provide a call out list, the last outgoing call number/entry can be redialled.

4. Press the up/down buttons to select the desired call list.
5. Press the **OK** button.
6. Press the up/down buttons to select the desired phone number.
7. Press the **OK** button.

## Redialling the last dialled number

1. Press the **PHONE** button.
2. Press the up/down arrow buttons until **REDIAL** is displayed.
3. Press the **OK** button.

# Telephone

---

## Receiving an incoming call

### Accepting an incoming call

Incoming calls can be accepted by pressing the seek down button, or by pressing the **OK** button.

### Rejecting an incoming call

Incoming calls can be rejected by:

- pressing the seek up button, or
- pressing the arrow down button to highlight **REJECT** and then pressing the **OK** button.

## Receiving a second incoming call

**Note:** *The second incoming call function must be activated in your phone.*

If there is an incoming call whilst there is an ongoing call, a beep will be heard and you will have the option to end the active call and to accept the incoming call.

### Accepting a second incoming call

**Note:** *The first incoming call will be disconnected and replaced by the second incoming call.*

Second incoming calls can be accepted by pressing the seek down button on the steering wheel or on the audio unit, or by pressing the **OK** button on the audio unit.

### Rejecting a second incoming call

Second incoming calls can be rejected by:

- pressing the seek up button, or
- pressing the arrow down button to highlight **REJECT** and then pressing the **OK** button.

Second incoming calls can be rejected by pressing function button 4.

## Muting the microphone

**Note:** *During a call, it is possible to mute the microphone. Whilst muted, confirmation will appear in the display.*

Press function button 1. Press the button once again to turn this function off.

## Changing the active phone

**Note:** *Phones must be bonded to the system before they can be made active.*

**Note:** *After bonding a phone to the system, this becomes the active phone.*

1. Press the **PHONE** button.
2. Press the up/down buttons until **SELECT PHONE** is shown.
3. Press the **OK** button.
4. Scroll through the different stored phones by using the up/down buttons to display the bonded phones.
5. Press the **OK** button to select the phone which is to be the active phone.

## Debonding a bonded phone

A bonded phone can be deleted from the system at any time, unless a phone call is in progress.

1. Press the **PHONE** button.
2. Press the up/down buttons until **SELECT PHONE** is shown.
3. Press the **OK** button.
4. Press the up/down buttons to highlight the required phone.
5. Press function button 1.

# Voice control

---

## PRINCIPLE OF OPERATION

### CAUTION

 Using the system with the engine off will drain the battery.

Voice recognition enables operation of the system without the need to divert your attention from the road ahead in order to change settings, or receive feedback from the system.

Whenever you issue one of the defined commands with the system active, the voice recognition system converts your command into a control signal for the system. Your inputs take the form of dialogues or commands. You are guided through these dialogues by announcements or questions.

Please familiarise yourself with the functions of the system before using voice recognition.

### Supported commands

The voice control system allows you to control the following vehicle functions:

- Bluetooth phone
- radio
- CD Player
- external device (USB)
- external device (iPod)
- automatic climate control

### System response

As you work through a voice session the system will prompt you with a beep tone each time the system is ready to proceed.

Do not try to give any commands until the beep tone has been heard. The voice control system will repeat each spoken command back to you.

If you are not sure how to continue say "HELP" for assistance or "CANCEL" if you do not wish to continue.

The "HELP" function provides only a subset of the available voice commands. Detailed explanations of all possible voice commands can be found on the following pages.

### Voice commands

All voice commands should be given using a natural speaking voice, as if speaking to a passenger or on the phone. Your voice level should be dependant on the surrounding noise level inside or outside the vehicle but do not shout.

## USING VOICE CONTROL

### System operation

The order and content of the voice controls are given in the following lists. The tables show the sequence of user voice commands and system responses for each available function.

<> indicates a number or stored name tag to be inserted by the user.

### Short cuts

There are a number of voice command short cuts available, which allow you to control some vehicle features without having to follow the complete command menu. These are:

- phone: "MOBILE NAME", "DIAL NUMBER", "DIAL NAME", and "REDIAL"
- automatic climate control: "TEMPERATURE", "AUTO MODE", "DEFROSTING/DEMISTING ON" and "DEFROSTING/DEMISTING OFF"
- radio: "TUNE NAME"

# Voice control

- external device (USB): "TRACK"
- external device (iPod): "TRACK"

## Start communicating with the system

Before you can start talking to the system you first have to press the **VOICE** button for each operation and wait until the system answers with a beep. See **Voice control** (page 42).

Press the button again to cancel the voice session.

## Name tag

The name tag functionality can support the phone, audio and navigation features by using the "STORE NAME" function. You can assign name tags to items such as favourite radio stations and personal phone contacts. See **Audio unit commands** (page 183). See **Telephone commands** (page 190).

- Store up to 20 name tags per function.
- The average recording time for each name tag is approximately 2-3 seconds.

## AUDIO UNIT COMMANDS

### CD Player

You can control playback directly by voice control.

### Overview

The overview below shows the available voice commands. The following lists will give further information about the complete command menu in selected examples.

"CD PLAYER"
"HELP"
"PLAY"
"TRACK"*
"SHUFFLE ALL "
"SHUFFLE FOLDER"**
"SHUFFLE OFF"
"REPEAT FOLDER"**
"REPEAT TRACK"
"REPEAT OFF"

\* Can be used as a shortcut.

\*\* Only available if the CD contains audio data files like MP3.

# Voice control

## Track

You can choose a track on your CD directly.

Steps	User says	System answer
1	"CD PLAYER"	"CD PLAYER"
2	"TRACK"*	"TRACK NUMBER PLEASE"
3	"<a number between 1 and 99>"**	"TRACK <number>"

\* Can be used as a shortcut.

\*\* Additionally, numbers can be spoken as up to four single digits (for example "2", "4", "5" for track 245)

## Shuffle all

To set random playback.

Steps	User says	System answer
1	"CD PLAYER"	"CD PLAYER"
2	"SHUFFLE ALL"	

## Radio

The radio voice commands support the functionality of the radio and allow you to tune radio stations by voice control.

## Overview

The overview below shows the available voice commands. The following lists will give further information about the complete command menu.

"RADIO"
"HELP"
"AM"
"FM"
"TUNE NAME"*
"DELETE NAME"
"DELETE DIRECTORY"
"PLAY DIRECTORY"

# Voice control

"RADIO"
"STORE NAME"
"PLAY"

\* Can be used as a shortcut.

## Tune frequency

This function allows you to tune your radio by voice commands.

Steps	User says	System answer
1	"RADIO"	"RADIO"
2	"AM"	"AM FREQUENCY PLEASE"
	"FM"	"FM FREQUENCY PLEASE"
3	"<frequency>"*	"TUNE <frequency>"

\* The frequency may be entered in a variety of ways. Refer below for representative examples.

FM band: 87.5 - 108.0 in increments of 0.1

- "Eighty nine point nine" (89.9)
- "Ninety" (90.0)
- "One hundred point five" (100.5)
- "One zero one point one" (101.1)
- "One zero eight" (108.0)

AM/MW band: 531 - 1602 in increments of 9

AM/LW band: 153 - 281 in increments of 1

- "Five thirty one" (531)
- "Nine hundred" (900)
- "Fourteen forty" (1440)
- "Fifteen zero three" (1503)
- "Ten eighty" (1080)

## Store name

If you have tuned a radio station, you can store it with a name in the directory.

Steps	User says	System answer
1	"RADIO"	"RADIO"
2	"STORE NAME"	"STORE NAME" "NAME PLEASE"
3	"<name>"	"REPEAT NAME PLEASE"

# Voice control

Steps	User says	System answer
4	"<name>"	"STORING NAME" "<name> STORED"

## Tune name

This function allows you to call up a stored radio station.

Steps	User says	System answer
1	"RADIO"	"RADIO"
2	"TUNE NAME"*	"NAME PLEASE"
3	"<name>"	"TUNE <name>"

\* Can be used as a shortcut.

## Delete name

This function allows you to delete a stored radio station.

Steps	User says	System answer
1	"RADIO"	"RADIO"
2	"DELETE NAME"	"NAME PLEASE"
3	"<name>"	"DELETE <name>" "CONFIRM YES OR NO"
4	"YES"	"DELETED"
	"NO"	"COMMAND CANCELLED"

## Play directory

This function allows you to let the system tell you all of the stored radio stations.

Steps	User says	System answer
1	"RADIO"	"RADIO"

# Voice control

Steps	User says	System answer
2	"PLAY DIRECTORY"	"PLAY <DIRECTORY>"

## Delete directory

This function allows you to delete all stored radio stations at once.

Steps	User says	System answer
1	"RADIO"	"RADIO"
2	"DELETE DIRECTORY"	"DELETE DIRECTORY" "CONFIRM YES OR NO"
3	"YES"	"RADIO DIRECTORY DELETED"
	"NO"	"COMMAND CANCELLED"

## Play

This function switches the audio source to the radio mode.

Steps	User says	System answer
1	"RADIO"	"RADIO"
2	"PLAY"	

## Auxiliary input

This function allows you to switch the audio source to the attached auxiliary input device.

Steps	User says	System answer
1	"EXTERNAL DEVICE"	"EXTERNAL DEVICE"
2	"LINE IN"	"LINE IN"

# Voice control

## External devices - USB

These voice commands support the functionality of an external USB device which may be connected to the audio unit.

## Overview

The overview below shows the available voice commands. The following lists will give further information about the complete command menu in selected examples.

<b>"EXTERNAL DEVICE", "USB"</b>
"HELP"
"PLAY"
"TRACK"*
"PLAYLIST"**
"FOLDER"**
"SHUFFLE ALL"
"SHUFFLE FOLDER"
"SHUFFLE PLAYLIST"
"SHUFFLE OFF"
"REPEAT TRACK"
"REPEAT FOLDER"
"REPEAT OFF"

\* Can be used as a shortcut.

\*\* Playlists and folders activated by voice control must be assigned special filenames. See **General information** (page 198).

## USB play

This function allows you to switch the audio source to the attached USB device.

Steps	User says	System answer
1	"EXTERNAL DEVICE"	"EXTERNAL DEVICE"
2	"USB"	"USB"
3	"PLAY"	

# Voice control

## USB Track

You can choose a track on your USB device directly.

Steps	User says	System answer
1	"EXTERNAL DEVICE"	"EXTERNAL DEVICE"
2	"USB"	"USB"
3	"TRACK"	"TRACK NUMBER PLEASE"
4	"<a number between 1 and 99>"*	"TRACK <number>"

\* Additionally, numbers can be spoken as up to four single digits (for example "2", "4", "5" for track 245)

## External devices - iPod

These voice commands support the functionality of an iPod which may be connected to the audio unit.

## Overview

The overview below shows the available voice commands. The following lists will give further information about the complete command menu in selected examples.

"EXTERNAL DEVICE", "IPOD"
"HELP"
"PLAY"
"TRACK"*
"PLAYLIST"**
"SHUFFLE ALL"
"SHUFFLE PLAYLIST"
"SHUFFLE OFF"
"REPEAT TRACK"
"REPEAT OFF"

\* Can be used as a shortcut.

\*\* Playlists activated by voice control must be assigned special filenames. See **General information** (page 198).

# Voice control

## iPod Track

You can choose a track off the all titles list of your iPod directly.

Steps	User says	System answer
1	"EXTERNAL DEVICE"	"EXTERNAL DEVICE"
2	"IPOD"	"IPOD"
3	"TRACK"*	"TRACK NUMBER PLEASE"
4	"<a number between 1 and 99>"**	"TRACK <number>"

\* Can be used as a shortcut.

\*\* Additionally, numbers can be spoken as up to five single digits (for example "5", "2", "4", "5", "3" for track 52453), to a limit of 65535.

## iPod playlist

You can choose a playlist from your iPod directly.

Steps	User says	System answer
1	"EXTERNAL DEVICE"	"EXTERNAL DEVICE"
2	"IPOD"	"IPOD"
3	"PLAYLIST"*	"PLAYLIST NUMBER PLEASE"
4	"<a number between 1 and 10>"	"PLAYLIST <number>"

\* Playlists activated by voice control must be assigned special filenames. See **General information** (page 198).

## TELEPHONE COMMANDS

### Phone

Your phone system allows you to create an additional phonebook. The stored entries can be dialed by voice control. Phone numbers stored by using voice control are stored on the vehicle system and not in your phone.

### Overview

The overview below shows the available voice commands. The following lists will give further information about the complete command menu in selected examples.

# Voice control

"PHONE"
"HELP"
"MOBILE NAME"*
"DIAL NUMBER"*
"DIAL NAME"*
"DELETE NAME"
"DELETE DIRECTORY"
"PLAY DIRECTORY"
"STORE NAME"
"REDIAL"*
"ACCEPT CALLS"
"REJECT CALLS"

\* Can be used as a shortcut.

## Phone functions

### Dial number

Phone numbers can be dialled after giving the name tag voice command.

Steps	User says	System answer
1	"PHONE"	"PHONE"
2	"DIAL NUMBER"*	"NUMBER PLEASE"
3	"<phone number>"	"<phone number> CONTINUE?"
4	"DIAL"	"DIALLING"
	"CORRECTION"	"<repeat last part of number> CONTINUE?"

\* Can be used as a shortcut.

# Voice control

## Dial name

Phone numbers can be dialled after giving the name tag voice command.

Steps	User says	System answer
1	"PHONE"	"PHONE"
2	"DIAL NAME"*	"NAME PLEASE"
3	"<name>"	"DIAL <name>" "CONFIRM YES OR NO"
4	"YES"	"DIALLING"
	"NO"	"COMMAND CANCELLED"

\* Can be used as a shortcut.

## Redial

This function allows you to redial the last dialled phone number.

Steps	User says	System answer
1	"PHONE"	"PHONE"
2	"REDIAL"*	"REDIAL" "CONFIRM YES OR NO"
3	"YES"	"DIALLING"
	"NO"	"COMMAND CANCELLED"

\* Can be used as a shortcut.

## Mobile name

This function allows you to access phone numbers stored with a name tag in your mobile phone.

Steps	User says	System answer
1	"PHONE"	"PHONE"
2	"MOBILE NAME"*	"MOBILE NAME" "<phone dependent dialogue>"

\* Can be used as a shortcut.

# Voice control

## DTMF (Tone dialling)

This function transfers spoken numbers into DTMF tones. For example, to make a remote enquiry to your home answering machine or to enter a PIN number etc.

**Note:** DTMF can only be used during an ongoing call. Press the VOICE button and wait for the system prompt.

Can only be used with vehicles installed with a dedicated VOICE button.

Steps	User says	System answer
1		"NUMBER PLEASE"
2	"<numbers 1 to 9, zero, hash, star>"	

## Create a phonebook

### Store name

New entries can be stored with the "STORE NAME" command. This feature can be used to dial a number by calling up the name instead of the full phone number.

Steps	User says	System answer
1	"PHONE"	"PHONE"
2	"STORE NAME"	"STORE NAME" "NAME PLEASE"
3	"<name>"	"REPEAT NAME PLEASE"
4	"<name>"	"STORING NAME" "<name> STORED" "NUMBER PLEASE"
5	"<phone number>"	"<phone number>"
6	"STORE"	"STORING NUMBER" "<phone number>" "NUMBER STORED"

### Delete name

Stored names can also be deleted from the directory.

# Voice control

---

Steps	User says	System answer
1	"PHONE"	"PHONE"
2	"DELETE NAME"	"NAME PLEASE"
3	"<name>"	"DELETE <name>" "CONFIRM YES OR NO"
4	"YES"	"<name> DELETED"
	"NO"	"COMMAND CANCELLED"

## Play directory

Use this function to let the system tell you all stored entries.

Steps	User says	System answer
1	"PHONE"	"PHONE"
2	"PLAY DIRECTORY"	"PLAY DIRECTORY"

## Delete directory

This function allows you to delete all entries in one go.

Steps	User says	System answer
1	"PHONE"	"PHONE"
2	"DELETE DIRECTORY"	"DELETE DIRECTORY" "CONFIRM YES OR NO"
3	"YES"	"DIRECTORY DELETED"
	"NO"	"COMMAND CANCELLED"

## Main settings

### Reject calls

Calls can be set to be automatically rejected using voice control.

# Voice control

Steps	User says	System answer
1	"PHONE"	"PHONE"
2	"REJECT CALLS"	"REJECT CALLS"
	"ACCEPT CALLS"*	"ACCEPT CALLS"

\* use this command to turn the reject mode off

## CLIMATE CONTROL COMMANDS

### Climate

The climate voice commands supports the functionality of the fan speed, temperature and mode settings. Not all functions are available on all vehicles.

### Overview

The overview below shows the available voice commands. The following lists will give further information about the complete command menu in selected examples.

"CLIMATE"
"HELP"
"FAN"*
"DEFROSTING/DEMISTING ON"*
"DEFROSTING/DEMISTING OFF"*
"TEMPERATURE"*
"AUTO MODE"*

\* Can be used as a shortcut. On vehicles fitted with an English language module the "FAN" shortcut is not available.

### Fan

This function allows you to adjust the fan speed.

# Voice control

Steps	User says	System answer
1	"CLIMATE"	"CLIMATE"
2	"FAN"*	"FAN SPEED PLEASE"
3	"MINIMUM"	"FAN MINIMUM"
	"<a number between 1 and 7>"	"FAN <number>"
	"MAXIMUM"	"FAN MAXIMUM"

\* Can be used as a shortcut. On vehicles fitted with an English language module the "FAN" shortcut is not available.

## Defrosting/Demisting

Steps	User says	System answer
1	"CLIMATE"	"CLIMATE"
2	"DEFROSTING ON/DEMISTING ON"*	"DEFROSTING ON/DEMISTING ON"
	"DEFROSTING OFF/DEMISTING OFF"*	"DEFROSTING OFF/DEMISTING OFF"

\* Can be used as a shortcut.

## Temperature

This function allows you to adjust the temperature.

Steps	User says	System answer
1	"CLIMATE"	"CLIMATE"
2	"TEMPERATURE"*	"TEMPERATURE PLEASE"
3	"MINIMUM"	"TEMPERATURE MINIMUM"
	"<a number between 15 and 29 °C with 0.5 increments>" or "<a number between 59 and 84 °F>"	"TEMPERATURE <number>"

# Voice control

---

Steps	User says	System answer
	"MAXIMUM"	"TEMPERATURE MAXIMUM"

\* Can be used as a shortcut.

## Auto mode

Steps	User says	System answer
1	"CLIMATE"	"CLIMATE"
2	"AUTO MODE"*	"AUTO MODE"

\* Can be used as a shortcut. Can be deactivated by selecting a different temperature or fan speed.

# Connectivity

## GENERAL INFORMATION

### CAUTIONS

 Take care when handling external devices with exposed electrical connectors (such as the USB plug). Always replace the protective cap/shield when possible. There may be a risk of electrostatic discharge causing damage to the device.

 Do not touch or handle the USB socket in the vehicle. Cover the socket when not in use.

 Only use USB Mass-Storage device compliant devices.

 Always switch your audio unit to a different source (for example the radio) before unplugging the USB device.

 Do not install or connect USB hubs or splitters.

**Note:** *The system is only designed to recognize and read suitable audio files from a USB device that conforms to the USB Mass-Storage device class or an iPod. Not all available USB devices can be guaranteed to function with the system.*

**Note:** *It is possible to connect compatible devices with a trailing USB lead as well as those that plug into the vehicle USB socket directly (for example USB memory sticks and pen drives).*

**Note:** *Some USB devices with a higher power consumption may not be compatible (for example some larger hard drives).*

**Note:** *Access time to read the files on the external device will vary depending upon factors such as the file structure, size and device content.*

The system supports a range of external devices, to fully integrate with your audio unit via the USB and auxiliary input sockets. Once connected, control of the external device is possible via the audio unit.

A list of typical compatible devices are shown below:

- USB memory sticks
- USB portable hard drives
- Some MP3 players with USB connection
- iPod media players (refer to **www.ford-mobile-connectivity.com** for latest compatibility list).

The system is USB 2.0 full speed compatible, USB 1.1 host compliant and supports FAT 16/32 file systems.

## Information on audio file structures for external devices

### USB

Create only a single partition on the USB device.

If playlists are created, they must contain correct file paths referenced to the USB device. It is recommended to create the playlist after the audio files have been transferred to the USB device.

Playlists must be created in .m3u format.

Audio files must be in .mp3 format.

Do not exceed the following limits:

- 1000 items per folder (files, folders and playlists)
- 5000 folders per USB device (including playlists)
- 8 subfolder levels.

# Connectivity

To enable voice control for custom playlists and folders, follow the procedure below:

- Create folders named with the structure "**Ford<\*>**" where <\*> is a number 1-10. For example "**Ford3**" without an extension.
- Create playlists named with the structure "**Ford<\*>.m3u**" where <\*> is a number 1-10. For example "**Ford5.m3u**" without any space between "**Ford**" and the number.

Thereafter, custom folders and playlists will be selectable with voice control. See **Audio unit commands** (page 183).

## iPod

To enable voice control for custom playlists, create playlists named with the structure "**Ford<\*>**" where <\*> is a number 1-10. For example "**Ford7**" without any space between "**Ford**" and the number.

Thereafter, playlists will be selectable with voice control. See **Audio unit commands** (page 183).

## CONNECTING AN EXTERNAL DEVICE

### WARNING



Make sure the external device is securely mounted within the vehicle, and that trailing connections do not obstruct any of the driving controls.

External devices may be connected using the auxiliary input socket and the USB port. See **Auxiliary input (AUX IN) socket** (page 86). See **USB port** (page 87).

## Connection

Plug in the device, and if necessary secure it to prevent movement within the vehicle.

### Connecting an iPod

For optimum convenience and audio quality, we recommend that you purchase a dedicated single connection lead available from your dealer.

Alternatively, it is possible to connect your iPod using the standard iPod USB cable and a separate 3.5mm audio jack lead. If using this method preset the iPod volume to maximum and turn off any equalizer settings before making the connections:

- Connect the headphone output of the iPod to the AUX IN socket.
- Connect the USB cable from the iPod to the vehicle USB socket.

## CONNECTING AN EXTERNAL DEVICE - VEHICLES WITH: BLUETOOTH

### Connecting a Bluetooth audio device

#### CAUTION



As various standards exist, manufacturers are able to implement a variety of profiles in their Bluetooth devices. Because of this, an incompatibility can occur between the Bluetooth device and the system, which in some cases may limit system functionality. To avoid this situation, only recommended devices should be used.

Please visit the website [www.ford-mobile-connectivity.com](http://www.ford-mobile-connectivity.com) for full details.

# Connectivity

## Bonding the device

To connect the device to the system follow the same procedure as for Bluetooth hands free phones. See **Bluetooth setup** (page 178).

## Operating the device

**Note:** *The seek buttons and file information will only work on certain phones and devices.*

Select Bluetooth audio as the active source.

1. Select **AUX**.
2. Press the up and down arrow buttons to select the desired function.
3. Press the **OK** button.

Tracks can be accessed by skipping forwards and backwards using the steering wheel controls, or directly from the audio unit controls.

## Audio control

Press the seek up and down keys to skip backwards and forwards through tracks.

Press and hold the seek keys to enable fast rewind/fast forward through track content.

Press the **INFO** button or function button 4 to display the following:

- Title.
- Artist.
- Album.
- File name.

## USING A USB DEVICE

Various icons are used to identify types of audio file, folders etc.



USB device is the active source



Folder



Playlist



Album



Artist



Filename



Track title



Information not available

## Operation

Select the USB device as the audio source by repeatedly pressing the **AUX** button until the USB screen appears in the display. After first connecting the USB device, the first track within the first folder will start to play automatically. Subsequently, following audio source switching, the position of playback on the USB device is remembered.

To browse the device contents, press the up/down arrow key or the **OK** button once.

# Connectivity

The display will show the track information, together with other important information described below:

- A vertical scroll bar on the right side of the display shows the current position of the folder view.
- ">" after an entry indicates a further level down is readable (for example a folder named after an album, with individual album tracks within that folder).
- "<" before the list indicates that a further level up is readable.
- Icons to the left of track/folder text indicate the type of file/folder. Refer to the list for an explanation of these icons.

To navigate the USB device contents, use the up/down arrow keys to scroll through lists, and the left/right keys to move up or down within the folder hierarchy. Once your desired track, playlist or folder is highlighted, press the **OK** button to select playback.

**Note:** *If you wish to jump to the top level of the USB device contents, press and hold the left arrow key.*

## Audio control

Press the seek up and down keys to skip backwards and forwards through tracks.

Press and hold the seek keys to enable fast rewind/fast forward through track content.

Use the function buttons to enable shuffle, repeat and scan with respect to the whole device, folders and playlists.

Press the **INFO** button or function button 4 to display the following:

- title
- artist
- album

- folder name
- file name.

## USING AN IPOD

Various icons are used to identify types of audio file, folders etc.



iPod is the active source



iPod playlist



iPod artist



iPod album



iPod genre



iPod song



iPod generic category



iPod generic media file

## Operation

Connect the iPod. See **Connecting an external device** (page 199).

Select the iPod as the audio source by repeatedly pressing the **AUX** button until the iPod screen appears in the display.

# Connectivity

---

The iPod menu list for browsing contents will be available through the radio display. Navigation of the contents follows the same principles as for iPod standalone use (for example search by artist, title, etc.). To browse the iPod contents, press the up/down arrow key or the OK button once.

The display will show the track information, together with other important information described below:

- A vertical scroll bar on the right side of the display shows the current position of the list view.
- ">" after an entry indicates a further level down is readable (for example all albums by a particular artist).
- "<" before the list indicates that a further level up is readable.
- An icon on the left side indicates the type of the currently displayed list (for example list of albums). Refer to the list for an explanation of these icons.

To navigate the iPod contents, use the up/down arrow keys to scroll through lists, and the left/right keys to move up or down within the hierarchy. Once your desired track, playlist, album, artist or genre is highlighted, press the OK button to select playback.

**Note:** *If you wish to jump to the top level of the iPod contents, press and hold the left arrow key.*

## Audio control

Press the seek up and down keys to skip backwards and forwards through tracks.

Press and hold the seek keys to enable fast rewind/fast forward through track content.

Use the function buttons to enable shuffle and repeat with respect to playlists.

Press function button 3 to scan the whole device or a playlist if it is in operation.

Press the **INFO** button or function button 4 to display the following:

- title
- artist
- album.

## ROAD SAFETY

### WARNINGS



The system provides you with information designed to help you reach your destination quickly and safely.



For reasons of safety, the driver should only program the system when the vehicle is stationary.



The system provides no assistance with respect to stop signs, traffic lights, areas under construction or other important safety information.



Do not use the system until you have familiarised yourself with its operation.



Only view the system display when driving conditions permit.

---

### Safety information

Read and follow all stated safety precautions. Failure to do so may increase your risk of collision and personal injury. Ford Motor Company shall not be liable for any damages of any type arising from failure to follow these guidelines.

If detailed viewing of route instructions is necessary, pull off the road when it is safe to do so and park your vehicle.

Do not use the navigation system to locate emergency services.

To use the system as effectively and safely as possible, always use the latest navigation information. Your dealer will be able to assist with this.

# Navigation system

## GETTING STARTED

### CAUTION

 Using the system with the engine off will drain the battery.

**Note:** You will be charged when sending and receiving text messages.

**Note:** Refer to your phone handbook for all phone functions and operation.

**Note:** Keep the activation code (printed on the installation guide) in a safe place.

**Note:** Retain the activation text message in your mobile phone inbox.

## Compatibility of phones

### CAUTION

 As no common agreement exists, mobile phone manufacturers are able to implement a variety of profiles in their Bluetooth devices. Because of this, an incompatibility can occur between the phone and hands-free system, which in some cases may significantly degrade the system performance. To avoid this situation, only recommended phones should be used.

Please visit the website [www.ford-mobile-connectivity.com](http://www.ford-mobile-connectivity.com) for full details.

## Installing the micro SD card

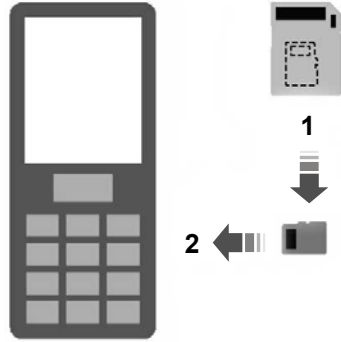

E114212

1. Remove the micro SD card from the adaptor.
2. Insert the micro SD card into the mobile phone.

## Activating the mobile phone navigation system

**Note:** The radio must be switched on before connecting the mobile phone to the in-car GPS receiver.

**Note:** The Ford Mobile Navigation must be installed and activated on your mobile phone.

**Note:** It is possible to activate up to a **maximum** of three phones.

**Note:** Detailed instructions are available on the micro SD card and at [www.ford-mobile-connectivity.com](http://www.ford-mobile-connectivity.com).

To connect the device to the system follow the same procedure as for Bluetooth hands free phones. See **Bluetooth setup** (page 178).

1. Switch the radio on.

# Navigation system

---



E114213

2. Switch your mobile phone on and start the "Ford Mobile Navigation".
3. Choose "Select Destination".
4. Choose "Enter Address".
5. Change route options if necessary and start the route guidance.
6. The vehicle display will show the turn information. Voice instructions are heard via the vehicle speakers.

**Note:** *Your mobile phone will display your current position.*

7. You are able to exit the application and continue your route guidance after restarting the application.

# Appendices

---

## TYPE APPROVALS

### FCC/INDUSTRY CANADA NOTICE

This device complies with Part 15 of the FCC Rules. Operation is subject to the following two conditions: (1) this device may not cause harmful interference, and (2) this device must accept any interference received, including interference that may cause undesired operation.

FCC ID: WJLRX-42

IC: 7847A-RX42

Changes or modifications to your device not expressly approved by the party responsible for compliance can void the user's authority to operate the equipment.

### RX-42 - declaration of conformity

We, the party responsible for compliance, declare under our sole responsibility that the Handset Integration product RX-42 is in conformity with the provisions of the following Council Directive: 1999/5/EC. A copy of the Declaration of Conformity can be found at:

[www.novero.com/declaration\\_of\\_conformity](http://www.novero.com/declaration_of_conformity)

The Bluetooth word mark and logos are owned by the Bluetooth SIG, Inc. and any use of such marks by Ford Motor Company is under license. Other trademarks and trade names are those of their respective owners.

## TYPE APPROVALS

iPod is a trademark of Apple Inc.

## TYPE APPROVALS



© 2008 NAVTEQ B.V. All rights reserved.

# Appendices

(AT)	"© Bundesamt für Eich- und Vermessungswesen"
(PL)	"© EuroGeographics"
(FR)	"source: Géoroute® IGN France & BD Carto® IGN France"
(DE)	"Die Grundlagendaten wurden mit Genehmigung der zuständigen Behörden entnommen"
(GB)	"Based upon Crown Copyright material."
(GR)	"Copyright Geomatics Ltd."
(IT)	"La Banca Dati Italiana è stata prodotta usando quale riferimento anche cartografia numerica ed al tratto prodotta e fornita dalla Regione Toscana."
(NO)	"Copyright © 2000; Norwegian Mapping Authority"
(PT)	"Source: IgeoE – Portugal"
(ES)	"Información geográfica propiedad del CNIG"
(SE)	"Based upon electronic data © National Land Survey Sweden."
(CH)	"Topografische Grundlage: © Bundesamt für Landestopographie"

## ELECTROMAGNETIC COMPATIBILITY

### WARNINGS



Your vehicle has been tested and certified to legislations relating to electromagnetic compatibility (72/245/EEC, UN ECE Regulation 10 or other applicable local requirements). It is your responsibility to ensure that any equipment you have fitted complies with applicable local legislations. Have any equipment fitted by properly trained technicians.

### WARNINGS



Radio frequency (RF) transmitter equipment (e.g. cellular telephones, amateur radio transmitters etc.) may only be fitted to your vehicle if they comply with the parameters shown in the table below. There are no special provisions or conditions for installations or use.



Do not mount any transceiver, microphones, speakers, or any other item in the deployment path of the airbag system.



Do not fasten antenna cables to original vehicle wiring, fuel pipes and brake pipes.

# Appendices

## WARNINGS



Keep antenna and power cables at least 100mm from any electronic

## WARNINGS

modules and airbags.

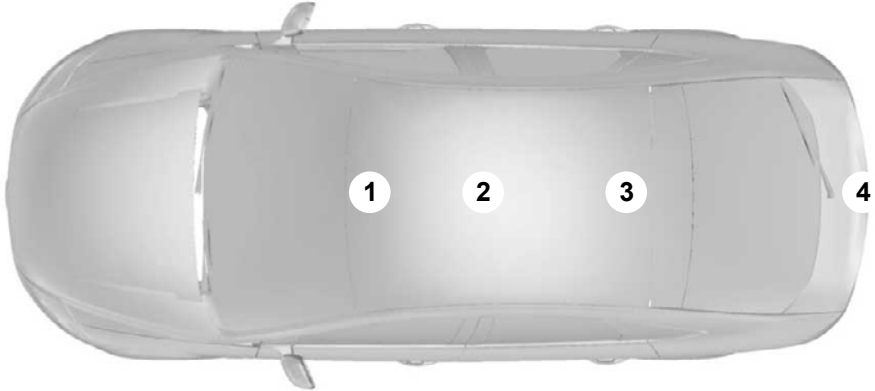

E85998

Frequency Band MHz	Maximum output power Watt (Peak RMS)	Antenna Positions
1 – 30	50 W	3, 4
30 – 54	50 W	1, 2, 3
68 – 87.5	50 W	1, 2, 3
142 – 176	50 W	1, 2, 3
380 – 512	50 W	1, 2, 3
806 – 940	10 W	1, 2, 3
1200 – 1400	10 W	1, 2, 3
1710 – 1885	10 W	1, 2, 3
1885 – 2025	10 W	1, 2, 3

**Note:** After the installation of RF transmitters, check for disturbances from and to all electrical equipment in the vehicle, both in the standby and transmit modes.

Check all electrical equipment:

- with the ignition **ON**
- with the engine running
- during a road test at various speeds.

# Appendices

---

Check that electromagnetic fields generated inside the vehicle cabin by the transmitter installed do not exceed applicable human exposure requirements.



# Index

## A

A/C	
See: Climate control.....	75
About this handbook.....	7
ABS	
See: Brakes.....	100
ABS driving hints	
See: Hints on driving with ABS.....	100
Accessories	
See: Parts and accessories.....	7
Adjusting the steering wheel.....	41
Adjusting the windscreen washer jets.....	45
Air conditioning	
See: Climate control.....	75
Air vents.....	75
Centre air vent.....	75
Side air vent.....	75
Alarm.....	40
Principle of operation.....	40
Alternative frequencies.....	170
Appendices.....	206
Arming the alarm.....	40
Automatic arming delay.....	40
Arming the engine immobiliser.....	39
Audible warnings and indicators.....	62
Automatic transmission.....	62
Key outside car.....	63
Lights on.....	63
Low fuel.....	63
Seat belt reminder.....	63
Audio control.....	41
Mode.....	41
Seek.....	41
Audio introduction.....	159
Audio system security.....	166
Audio troubleshooting.....	177
Audio unit commands.....	183
Auxiliary input.....	187
CD Player.....	183
External devices - iPod.....	189
External devices - USB.....	188
Radio.....	184
Audio unit menus.....	170
Audio unit operation.....	167
Audio unit overview.....	160
Auto-dimming mirror.....	58

Autolamps.....	48
Automatic climate control.....	78
Air distribution.....	78
Blower.....	78
Recirculated air.....	79
Setting the temperature.....	78
Switching off the automatic climate control.....	79
Switching the air conditioning on and off.....	79
Windscreen defrosting and demisting.....	79
Automatic transmission.....	97
Drive modes.....	98
Emergency park position release lever.....	99
General information.....	97
Hints on driving with an automatic transmission.....	98
Selector lever positions.....	97
Automatic volume control.....	170
Autostore control.....	168
Autowipers.....	43
Auxiliary input (AUX IN) socket.....	86

## B

Battery connection points.....	140
Bluetooth setup.....	178
Handling of phones.....	178
Requirements for Bluetooth connection.....	178
Bonnet lock	
See: Opening and closing the bonnet.....	128
Booster cables	
See: Using booster cables.....	139
Booster cushions.....	22
Booster cushion (Group 3).....	22
Booster seat (Group 2).....	22
Brake and clutch fluid check.....	134
Brakes.....	100
Principle of operation.....	100
Bulb changing	
See: Changing a bulb.....	50
Bulb specification chart.....	55

# Index

- C**
- Car wash
    - See: Cleaning the exterior.....137
  - Catalytic converter.....94
    - Driving with a catalytic converter.....95
  - Changing a bulb.....50
    - Central high mounted brake lamp.....54
    - Front fog lamps.....52
    - Headlamp.....50
    - Interior lamp.....54
    - Luggage compartment lamp.....54
    - Number plate lamp.....54
    - Reading lamps.....54
    - Rear fog lamps.....53
    - Rear lamps.....52
    - Side repeaters.....52
  - Changing a fuse.....115
  - Changing a road wheel.....141
    - Assembling the wheel brace.....143
    - Installing a road wheel.....145
    - Jacking and lifting points.....142
    - Locking wheel nuts.....141
    - Removing a road wheel.....144
    - Removing the wheel trim.....144
    - Vehicle jack.....141
    - Vehicles with a temporary spare wheel.....141
  - Changing the remote control battery.....30
    - Remote control with a folding key blade.....31
    - Remote control without a folding key blade.....32
  - Changing the wiper blades.....46
    - Rear window wiper blade.....46
    - Windscreen wiper blades.....46
  - Checking the wiper blades.....45
  - Child safety.....19
  - Child safety locks.....24
    - Left-hand side.....24
    - Right-hand side.....24
  - Child seat positioning.....20
  - Child seats.....19
    - Child restraints for different mass groups.....19
  - Cigar lighter.....85
  - Cleaning the exterior.....137
    - Body paintwork preservation.....137
    - Cleaning the chrome trim.....137
    - Cleaning the headlamps.....137
    - Cleaning the rear window.....137
  - Cleaning the interior.....137
    - Instrument cluster screens, LCD screens, radio screens.....138
    - Seat belts.....137
  - Climate control.....75
    - Principle of operation.....75
  - Climate control commands.....195
    - Climate.....195
  - Clock.....85
  - Coded keys.....39
  - Cold weather precautions.....113
  - Compact disc playback.....172
  - Compact disc player.....172
  - Compact disc track scanning.....173
    - Type 1.....173
    - Type 2 and 3.....173
  - Connecting an external device.....199
    - Connection.....199
  - Connecting an external device - Vehicles With: Bluetooth.....199
    - Connecting a Bluetooth audio device.....199
  - Connectivity.....198
    - General information.....198
  - Convenience features.....85
  - Coolant check
    - See: Engine coolant check.....133
  - Cruise control.....106
    - Principle of operation.....106
  - Cruise control
    - See: Using cruise control.....106
  - Cup holders.....85
- D**
- Detachable tow ball.....109
    - Driving with a trailer.....111
    - Driving without a trailer.....112
    - Inserting the tow ball arm.....110
    - Maintenance.....112
    - Removing the tow ball arm.....111
    - Unlocking the tow ball arm mechanism.....110

# Index

Diesel particulate filter (DPF).....91	Engine coolant check.....133
Regeneration.....92	Checking the coolant level.....133
Digital signal processing (DSP).....170	Topping up.....133
Changing the DSP settings.....170	Engine immobiliser.....39
DSP equaliser.....170	Principle of operation.....39
DSP occupancy.....170	Engine oil check.....133
Direction indicators.....49	Checking the oil level.....133
Disabling the passenger airbag.....29	Topping up.....133
Disabling the passenger airbag.....29	Engine oil dipstick - 1.25L Duratec-16V
Enabling the passenger airbag.....29	(Sigma)/1.4L Duratec-16V (Sigma)/1.6L
Fitting the passenger airbag deactivation	Duratec-16V Ti-VCT (Sigma).....132
switch.....29	Engine oil dipstick - 1.4L Duratorq-TDCi
Disarming the alarm.....40	(DV) Diesel/1.6L Duratorq-TDCi (DV)
Vehicles with keyless entry.....40	Diesel.....132
Vehicles without keyless entry.....40	Exterior mirrors.....57
Disarming the engine immobiliser.....39	Manual folding mirrors.....57
DPF	
See: Diesel particulate filter (DPF).....91	
Driving hints.....113	
Driving through water.....113	
Driving through water .....113	
<b>E</b>	
Electric exterior mirrors.....57	
Electric folding mirrors.....58	
Mirror tilting positions.....58	
Electric windows.....56	
Anti-trap function.....56	
Driver's door switches.....56	
Opening and closing the driver's window	
automatically.....56	
Resetting the memory of the electric	
window.....57	
Safety switch for rear windows.....56	
Electromagnetic compatibility.....207	
Emergency equipment.....114	
Ending compact disc playback.....175	
Engine compartment overview - 1.25L	
Duratec-16V (Sigma)/1.4L Duratec-16V	
(Sigma)/1.6L Duratec-16V Ti-VCT	
(Sigma).....129	
Engine compartment overview - 1.4L	
Duratorq-TDCi (DV) Diesel.....130	
Engine compartment overview - 1.6L	
Duratorq-TDCi (DV) Diesel.....131	
Engine coolant check.....133	
Checking the coolant level.....133	
Topping up.....133	
Engine immobiliser.....39	
Principle of operation.....39	
Engine oil check.....133	
Checking the oil level.....133	
Topping up.....133	
Engine oil dipstick - 1.25L Duratec-16V	
(Sigma)/1.4L Duratec-16V (Sigma)/1.6L	
Duratec-16V Ti-VCT (Sigma).....132	
Engine oil dipstick - 1.4L Duratorq-TDCi	
(DV) Diesel/1.6L Duratorq-TDCi (DV)	
Diesel.....132	
Exterior mirrors.....57	
Manual folding mirrors.....57	
<b>F</b>	
Fastening the seat belts.....27	
Fast forward/reverse.....172	
First aid kit.....114	
Floor mats.....87	
Fog lamp	
See: Front fog lamps.....48	
Front fog lamps.....48	
Fuel and refuelling.....93	
Technical specifications.....95	
Fuel consumption.....95	
Fuel consumption	
See: Technical specifications.....95	
Fuel filler flap.....93	
Vehicles without tyre repair kit.....94	
Vehicles with tyre repair kit.....94	
Fuel quality - Diesel.....93	
Long-term storage.....93	
Fuel quality - Petrol.....93	
Fuse box locations.....115	
Engine compartment fuse box.....115	
Passenger compartment fuse box.....115	
Fuses.....115	
Fuse specification chart.....116	
Engine compartment fuse box.....116	
Passenger compartment fuse box - Type	
1.....119	
Passenger compartment fuse box - Type	
2.....121	

# Index

- G**
- Gauges.....59
    - Fuel gauge.....59
  - Gearbox
    - See: Transmission.....97
  - General information on radio frequencies.....30
  - Getting started.....204
    - Activating the mobile phone navigation system.....204
    - Compatibility of phones.....204
    - Installing the micro SD card.....204
- H**
- Handbrake
    - See: Parking brake.....100
  - Hazard warning flashers.....49
  - Headlamp levelling.....48
    - Recommended headlamp levelling control positions.....49
  - Head restraints.....81
    - Adjusting the head restraint.....81
    - Removing the head restraint.....81
  - Heated seats.....84
  - Heated windows and mirrors.....80
    - Heated exterior mirrors.....80
    - Heated windows.....80
  - Heating
    - See: Climate control.....75
  - Hints on driving with ABS.....100
- I**
- Ignition switch.....88
  - Immobiliser
    - See: Engine immobiliser.....39
  - Important audio information.....159
    - Audio unit labels.....159
    - Disc labels.....159
  - Information displays.....64
    - General information.....64
  - Information messages.....70
  - Instruments.....59
  - Interior lamps.....49
    - Courtesy lamp.....49
    - Reading lamps.....50
  - Introduction.....7
  - iPod connection
    - See: Connecting an external device.....199
    - See: Connecting an external device - Vehicles With: Bluetooth.....199
  - iPod
    - See: Using an iPod.....201
  - ISOFIX anchor points.....23
    - Attaching a child seat with top tethers.....23
    - Top tether anchor points.....23
- J**
- Jump starting
    - See: Using booster cables.....139
- K**
- Keyless entry.....36
    - Disabled keys.....38
    - General information.....36
    - Locking and unlocking the doors with the key blade.....38
    - Locking the vehicle.....36
    - Passive key.....36
    - Unlocking the vehicle.....37
  - Keyless starting.....88
    - Failure to start.....89
    - Ignition on.....88
    - Starting a diesel engine.....89
    - Starting with automatic transmission.....89
    - Starting with manual transmission.....89
    - Stopping the engine when the vehicle is moving.....89
    - Stopping the engine with the vehicle stationary.....89
  - Keys and remote controls.....30
- L**
- Lighting control.....47
    - Headlamp flasher.....47
    - Home safe lighting.....47
    - Lighting control positions.....47
    - Main and dipped beam.....47
    - Parking lamps.....47
  - Lighting.....47

# Index

- Load carriers  
See: Roof racks and load carriers.....108
- Load carrying.....108  
General information.....108
- Locking and unlocking.....34  
Double locking.....34  
Locking.....34  
Locking and unlocking confirmation.....34  
Locking and unlocking the doors from  
inside.....35  
Locking the doors individually with the  
key.....35  
Luggage compartment lid.....35  
Unlocking.....34
- Locks.....34
- Luggage covers.....108
- ## M
- Maintenance.....127  
General information.....127  
Technical specifications.....135
- Manual climate control.....76  
Air distribution control.....76  
Blower.....76  
Recirculated air.....76  
System settings.....76
- Manual seats.....82  
Adjusting the angle of the seatback.....83  
Adjusting the height of the driver's  
seat.....83  
Adjusting the lumbar support.....83  
Folding the seatback forwards -  
3-door.....82  
Moving the seats forwards or  
backwards.....82  
Returning the seatback to the seating  
position - 3-door.....82
- Manual transmission.....97  
Selecting reverse gear.....97
- Map pockets.....86
- Message centre  
See: Information displays.....64
- Mirrors  
See: Heated windows and mirrors.....80  
See: Windows and mirrors.....56
- MP3 connection  
See: Connecting an external device.....199  
See: Connecting an external device -  
Vehicles With: Bluetooth.....199
- MP3 display options.....175  
CD text display options.....175
- MP3 file playback.....173  
File formats.....174  
ID3 Tag Version 2.....174  
ISO 9660 format.....173  
MP3 files playback order.....174  
MP3 navigation.....175  
Multi session.....173  
Playing a multi session disc.....174
- ## N
- Navigation introduction.....203  
Navigation system.....204  
News broadcasts.....170
- ## O
- Occupant protection.....25  
Principle of operation.....25
- Oil check  
See: Engine oil check.....133
- On/off control.....167  
See: Opening and closing the bonnet.....128
- ## O
- Opening and closing the bonnet.....128  
Closing the bonnet.....128  
Opening the bonnet.....128
- ## P
- Parking aid.....102  
Principle of operation.....102
- Parking aid  
See: Using the parking aid - Vehicles With:  
Front and Rear Parking Aid.....103  
See: Using the parking aid - Vehicles With:  
Rear Parking Aid.....102
- Parking brake.....100  
All vehicles.....100

# Index

- Parts and accessories.....7  
Look for the Ford logo on the following parts .....8  
Now you can be sure that your Ford parts are Ford parts.....7
- Personalised settings.....69  
Chime deactivation.....69  
Measure units.....69
- Programming the remote control.....30  
Programming a new remote control.....30  
Reprogramming the unlocking function.....30
- ## Q
- Quick start.....10  
Adjusting the steering wheel.....14  
Airbag.....17  
Autolamps.....16  
Automatic climate control.....15  
Autowipers.....16  
Direction indicators.....16  
Fuel filler flap.....18  
Instrument panel overview.....10  
Keyless entry.....13  
Keyless starting.....14  
Locking and unlocking.....13  
Manual climate control.....15  
Manual seats.....17
- ## R
- Rear fog lamps.....48  
Rear seats.....84  
Folding the seatbacks down.....84  
Rear view camera.....104  
Principle of operation.....104  
Rear window wiper and washers.....44  
Intermittent wipe.....44  
Rear window washer.....45  
Reverse gear wipe.....44  
Refuelling.....95  
Regional mode (REG).....171  
Remote control battery  
See: Changing the remote control battery.....30  
Remote control programming  
See: Programming the remote control....30
- Removing a headlamp.....50  
Repairing minor paint damage.....138  
Repeat compact disc tracks.....172  
Type 1.....172  
Type 2 and 3.....172  
Road Safety.....203  
Safety information.....203  
Roof racks and load carriers.....108  
Roof rack.....108  
Running-in.....113  
Brakes and clutch.....113  
Engine.....113  
Tyres.....113
- ## S
- Safety precautions.....93  
Satellite navigation unit holder.....87  
Adjusting the holder.....87  
Seat belt height adjustment.....28  
Seat belt reminder.....28  
Deactivating the seat belt reminder.....28  
Seat belts  
See: Fastening the seat belts.....27  
Seats.....81  
Security code.....166  
Shuffle/random.....172  
Type 1.....172  
Type 2 and 3.....172  
Sitting in the correct position.....81  
Snow chains  
See: Using snow chains.....150  
Sound button.....167  
Speed control  
See: Cruise control.....106  
Stability control.....101  
Principle of operation.....101  
Stability control  
See: Using stability control.....101  
Starter switch  
See: Ignition switch.....88  
Starting a diesel engine.....91  
Cold or hot engine.....91  
Starting a petrol engine.....90  
Cold or hot engine.....90  
Engine idle speed after starting.....91  
Flooded engine.....91

# Index

Starting the engine.....	88	Track selection.....	172
General information.....	88	Type 2 and 3.....	172
Station preset buttons.....	168	Traffic information control.....	168
Station tuning control.....	167	Activating traffic announcements.....	168
Manual tuning.....	167	Ending traffic announcements.....	169
Scan tuning.....	167	Traffic announcement volume.....	169
Seek tuning.....	167	Transmission.....	97
Steering wheel lock.....	90	Trip computer.....	69
Vehicles with keyless starting.....	90	Odometer.....	69
Vehicles without keyless starting.....	90	Trip computer.....	69
Steering wheel.....	41	Type approvals.....	206
Storage compartments.....	85	FCC/INDUSTRY CANADA NOTICE.....	206
Sun visors.....	85	RX-42 - declaration of conformity.....	206
Symbols glossary.....	7	Tyre care.....	149
Symbols in this handbook.....	7	Tyre pressures	
Symbols on your vehicle.....	7	See: Technical specifications.....	150
<b>T</b>			
Technical specifications.....	155	Tyre repair kit.....	146
Technical specifications.....	155	General information.....	146
Telephone commands.....	190	Inflating the tyre.....	147
Create a phonebook.....	193	Using the tyre repair kit.....	147
Main settings.....	194	Tyres	
Phone.....	190	See: Wheels and tyres.....	141
Phone functions.....	191	<b>U</b>	
Telephone controls.....	179	USB port.....	87
Remote control.....	179	USB	
Telephone setup.....	178	See: Using a USB device.....	200
Bond another Bluetooth phone.....	179	Using an iPod.....	201
Making a phone an active phone.....	179	Audio control.....	202
Phonebook.....	178	Operation.....	201
Phonebook categories.....	179	Using a USB device.....	200
Telephone.....	178	Audio control.....	201
General information.....	178	Operation.....	200
Telephone		Using booster cables.....	139
See: Using the telephone.....	179	To connect the booster cables.....	139
Toll reader.....	86	To start the engine.....	139
Towing a trailer.....	109	Using cruise control.....	106
Steep gradients.....	109	Cancelling the set speed.....	107
Towing points.....	125	Changing the set speed.....	106
Towing the vehicle on four		Resuming the set speed.....	107
wheels.....	125	Setting a speed.....	106
All vehicles.....	125	Switching cruise control off.....	107
Vehicles with automatic		Switching cruise control on.....	106
transmission.....	125	Using seat belts during pregnancy.....	28
Towing.....	109	Using snow chains.....	150
		Vehicles with stability control (ESP).....	150

# Index

Using stability control.....	101
Vehicles with stability control (ESP) switch.....	101
Using the parking aid - Vehicles With: Front and Rear Parking Aid.....	103
Manoeuvring with the parking aid.....	103
Switching the parking aid on and off.....	103
Using the parking aid - Vehicles With: Rear Parking Aid.....	102
Using the rear view camera.....	104
Activating the rear view camera.....	104
Deactivating the rear view camera.....	105
Switching the rear view camera on and off.....	105
Using the display.....	104
Using the telephone.....	179
Changing the active phone.....	181
Debonding a bonded phone.....	181
Making a call.....	180
Muting the microphone.....	181
Receiving an incoming call.....	181
Receiving a second incoming call.....	181
Using voice control.....	182
Name tag.....	183
System operation.....	182
Using winter tyres.....	150

## V

Vehicle battery.....	139
Vehicle care.....	137
Vehicle identification number (VIN).....	154
Vehicle Identification plate.....	154
Vehicle identification.....	154
Vehicle recovery.....	125
Ventilation See: Climate control.....	75
Vents See: Air vents.....	75
VIN See: Vehicle identification number (VIN).....	154
Voice control.....	42
Principle of operation.....	182

## W

Warning lamps and indicators.....	59
ABS warning lamp.....	60
Airbag warning lamp.....	60
Brake system lamp.....	60
Coolant temperature warning lamp.....	60
Cruise control indicator.....	60
Direction indicator.....	60
Doors open warning lamp.....	60
Engine warning lamps.....	61
Front fog lamp indicator.....	61
Frost warning lamp.....	61
Fuel in oil warning lamp.....	61
Glow plug indicator.....	61
Headlamp indicator.....	62
Ignition warning lamp.....	62
Low fuel level warning lamp.....	62
Main beam indicator.....	62
Message indicator.....	62
Oil pressure warning lamp.....	61
Power steering warning lamp.....	62
Rear fog lamp indicator.....	62
Seat belt reminder.....	62
Shift indicator.....	62
Stability control (ESP) indicator.....	62
Warning triangle.....	114
Washer fluid check.....	134
Washers See: Wipers and washers.....	43
Washing See: Cleaning the exterior.....	137
Waveband button.....	167
Wheels and tyres.....	141
General information.....	141
Technical specifications.....	150
Windows and mirrors.....	56
Windscreen washers.....	44
Windscreen wipers.....	43
Automatic wiper system.....	43
Intermittent wipe.....	43
Winter tyres See: Using winter tyres.....	150
Wipers and washers.....	43



Feel the difference

